



USER MANUAL

ProLite

LCD Monitor

ENGLISH

ProLite XB2779QQS

Thank you very much for choosing the iiyama LCD monitor. We recommend that you take a few minutes to read carefully through this brief but comprehensive manual before installing and switching on the monitor. Please keep this manual in a safe place for your future reference.





Dear user, we congratulate you on the purchase of your iiyama LCD.

For details on warranty and locally used pixel policies that apply directly after installation of your product please check the iiyama website.

To report a fault, please contact your local support centre found at www.iiyama.com/service

Things to check before you call the iiyama information line

- | if the power cable is connected securely and turned on?
- | if the display has been turned on?
- | if the signal cable is connected securely and the correct input selected?
- | if the computer has been restarted with the display connected?
- | if the graphics card is correctly installed with the latest drivers possible?
- | if the correct native resolution has been selected via 'Display Properties'?
- | If the R/G/B signal configuration is correct?
- | if the displays On Screen Menu is shown?
- | if the correct brightness and contrast settings have been set?
- | if given display tolerances and compatibility have been considered?
- | if via the On Screen Menu you have performed a Factory Reset/Recall?

Before reporting the screen defect, please prepare the following information/evidence:

- | model number *
- | purchase receipt and serial number *
- | name and address for collection
- | telephone/fax number, for availability during the day
- | convenient collection date (date, time)
- | short description of the defect

Important Note:

If there is no fault found in the collected equipment after inspection, the transferring party shall incur charges for transport and administration.

If you have checked all of the above and there is still no picture, call our information line for assistance in your country.

* see the identification plate on the back of the case.

CE MARKING DECLARATION OF CONFORMITY

This LCD monitor complies with the requirements of the EC/EU Directive 2014/30/EU "EMC Directive", 2014/35/EU "Low Voltage Directive", 2009/125/EC "ErP Directive" and 2011/65/EU "RoHS Directive".

The electro-magnetic susceptibility has been chosen at a level that gives correct operation in residential areas, business and light industrial premises and small-scale enterprises, inside as well as outside of the buildings. All places of operation are characterised by their connection to the public low voltage power supply system.

IYAMA CORPORATION: Wijkmeerstraat 8, 2131 HA Hoofddorp, The Netherlands

Model No. : PL2779QQ



We recommend recycling of used product. Please contact your dealer or iiyama service center. Recycle information is obtained via the Internet, using the address:
<http://www.iiyama.com>

You can access the Web page of different countries from there.

- We reserve the right to change specifications without notice.
- All trademarks used in this user manual are the property of their respective owners.
- As an ENERGY STAR® Partner, iiyama has determined that this product meets the ENERGY STAR® guidelines for energy efficiency.

TABLE OF CONTENTS

FOR YOUR SAFETY.....	1
SAFETY PRECAUTIONS.....	1
SPECIAL NOTES ON LCD MONITORS.....	3
CUSTOMER SERVICE.....	3
CLEANING.....	3
BEFORE YOU OPERATE THE MONITOR.....	4
FEATURES.....	4
CHECKING THE CONTENTS OF THE PACKAGE.....	4
WALL MOUNTING.....	5
FITTING AND REMOVAL OF BASE.....	6
CONTROLS AND CONNECTORS.....	7
CONNECTING YOUR MONITOR.....	8
COMPUTER SETTING.....	9
ADJUSTING THE HEIGHT AND THE VIEWING ANGLE.....	9
PANEL ROTATION.....	9
OPERATING THE MONITOR.....	10
ADJUSTMENT MENU CONTENTS.....	12
POWER MANAGEMENT FEATURE.....	20
TROUBLE SHOOTING.....	21
RECYCLING INFORMATION.....	22
APPENDIX.....	23
SPECIFICATIONS.....	23
DIMENSIONS.....	24
COMPLIANT TIMING.....	24

FOR YOUR SAFETY

SAFETY PRECAUTIONS

WARNING

STOP OPERATING THE MONITOR IF YOU ARE AWARE OF ANY PROBLEMS

If you notice any abnormal phenomena such as smoke, strange sounds or fumes, unplug the monitor and contact your dealer or iiyama service center immediately. Further use may be dangerous and can cause fire or electric shock.

NEVER REMOVE THE CABINET

High voltage circuits are inside the monitor. Removing the cabinet may expose you to the danger of fire or electric shock.

DO NOT PUT ANY OBJECT INTO THE MONITOR

Do not put any solid objects or liquids such as water into the monitor. In case of an accident, unplug your monitor immediately and contact your dealer or iiyama service center. Using the monitor with any object inside may cause fire, electric shock or damage.

INSTALL THE MONITOR ON A FLAT, STABLE SURFACE

The monitor may cause an injury if it falls or is dropped.

DO NOT USE THE MONITOR NEAR WATER

Do not use where water may be splashed or spilt onto the monitor as it may cause fire or electric shock.

OPERATE UNDER THE SPECIFIED POWER SUPPLY

Be sure to operate the monitor only with the specified power supply. Use of an incorrect voltage will cause malfunction and may cause fire or electric shock.

PROTECT THE CABLES

Do not pull or bend the power cable and signal cable. Do not place the monitor or any other heavy objects on the cables. If damaged, the cables may cause fire or electric shock.

ADVERSE WEATHER CONDITIONS

It is advisable not to operate the monitor during a heavy thunder storm as the continual breaks in power may cause malfunction. It is also advised not to touch the plug in these circumstances as it may cause electric shock.

CAUTION

INSTALLATION LOCATION

Do not install the monitor where sudden temperature changes may occur, or in humid, dusty or smoky areas as it may cause fire, electric shock or damage. You should also avoid areas where the sun shines directly on the monitor.

DO NOT PLACE THE MONITOR IN A HAZARDOUS POSITION

The monitor may topple and cause injury if not suitably located. Please also ensure that you do not place any heavy objects on the monitor, and that all cables are routed such that children may not pull the cables and possibly cause injury.

MAINTAIN GOOD VENTILATION

Ventilation slots are provided to keep the monitor from overheating. Covering the slots may cause fire. To allow adequate air circulation, place the monitor at least 10 cm (or 4 inches) from any walls. Do not remove the tilt stand when operating the monitor. Ventilation slots on the back of the cabinet will be blocked and the monitor may overheat if the stand is removed. This may cause fire or damage. Operating the monitor on its back, side, upside down or on a carpet or any other soft material may also cause damage.

DISCONNECT THE CABLES WHEN YOU MOVE THE MONITOR

When you move the monitor, turn off the power switch, unplug the monitor and be sure the signal cable is disconnected. If you do not disconnect them, it may cause fire or electric shock.

UNPLUG THE MONITOR

If the monitor is not in use for a long period of time it is recommended that it is left unplugged to avoid accidents.

HOLD THE PLUG WHEN DISCONNECTING

To disconnect the power cable or signal cable, always pull it by the plug. Never pull on the cable itself as this may cause fire or electric shock.

DO NOT TOUCH THE PLUG WITH WET HANDS

Pulling or inserting the plug with wet hands may cause electric shock.

WHEN YOU INSTALL THE MONITOR ON YOUR COMPUTER

Be sure the computer is strong enough to hold the weight of the monitor, otherwise, you may damage your computer.

CAREFUL! PROTECT YOUR HANDS AND FINGERS

- Be careful not to hurt your fingers or hands when you change the height or the angle.
- Injury can occur if care is not taken to avoid finger contact with the displays base when adjusting the height.

REMARK FOR 24/7 USAGE

This product is not specifically designed for 24/7 usage in all environments.

OTHERS

ERGONOMIC RECOMMENDATIONS

To eliminate eye fatigue, do not operate the monitor against a bright background or in a dark room. For optimal viewing comfort, the monitor should be just below eye level and 40-60 cm (16-24 inches) away from your eyes. When using the monitor over a prolonged time, a ten minute break every hour is recommended as looking at the screen continuously can cause eye strain.

SPECIAL NOTES ON LCD MONITORS

The following symptoms are normal with LCD monitors and do not indicate a problem.

- NOTE**
- When you first turn on the LCD monitor, the picture may not fit in the display area because of the type of computer that is used. In this case, adjust the picture position to the correct position.
 - You may find slightly uneven brightness on the screen depending on the desktop pattern you use.
 - Due to the nature of the LCD screen, an afterimage of the previous screen may remain after switching the image, when the same image is displayed for hours. In this case, the screen can be recovered slowly by changing the image or turning off the Power Switch for some hours.

CUSTOMER SERVICE

- NOTE**
- If you have to return your unit for service and the original packaging has been discarded, please contact your dealer or iiyama service center for advice or replacement packaging.

CLEANING

- WARNING**
- If you drop any materials or liquids such as water into the monitor when cleaning, unplug the power cable immediately and contact your dealer or iiyama service center.

- CAUTION**
- For safety reasons, turn off the power switch and unplug the monitor before you clean it.

- NOTE**
- To protect the LCD panel, do not scratch or rub the screen with a hard object.
 - Never use any of the following strong solvents. These will damage the cabinet and the LCD screen.

Thinner	Spray-type cleaner
Benzine	Wax
Abrasive cleaner	Acid or Alkaline solvent

- Touching the cabinet with any product made from rubber or plastic for a long time may cause degeneration or loss of paint on the cabinet.

CABINET Stains can be removed with a cloth lightly moistened with a mild detergent solvent. Then wipe the cabinet with a soft dry cloth.

LCD Periodic cleaning with a soft dry cloth is recommended.

SCREEN Don't use tissue paper etc. because these will damage the LCD screen.

BEFORE YOU OPERATE THE MONITOR

FEATURES

- ◆ Supports Resolutions up to 5120 × 2880
- ◆ High Contrast 1200:1 (Typical), Adv. Contrast Function Available / Brightness 440cd/m² (Typical)
- ◆ Flicker Free
- ◆ Blue Light Reducer
- ◆ Digital Character Smoothing
- ◆ Stereo Speakers
2 × 2W Stereo Speakers
- ◆ Power Management (ENERGY STAR® VESA DPMS Compliant)
- ◆ VESA Mounting Standard (100mm×100mm) Compliant
- ◆ Keyhole for Security Lock

CHECKING THE CONTENTS OF THE PACKAGE

The following accessories are included in your package. Check to see if they are enclosed with the monitor. If anything is missing or damaged, please contact your local iiyama dealer or regional iiyama office.

- | | | |
|---------------------|---------------------------------|---------------------------|
| ■ Power Cable* | ■ HDMI Cable (1pc) | ■ DisplayPort Cable (1pc) |
| ■ Stand Base | ■ Screw for stand fixing (3pcs) | ■ Safety Guide |
| ■ Quick Start Guide | | |

CAUTION

- * The rating of the Power Cable enclosed in 120V area is 10A/125V. If you are using a power supply higher than this rating, then a power cable with a rating of 10A/250V must be used. However, all guarantees and warranties are void for any problems or damage caused by a power cable not supplied by iiyama. An approved power cord greater or equal to H05VVF, 3G, 0.75mm² must be used.

WALL MOUNTING

- WARNING**
- When you use with the wall mounting, in consideration of thickness of the mounting stage, tighten the M4 Screw with washer which "L" length is 7mm to fasten the monitor. Using the screw longer than this may cause electric shock or damage because it may contact with the electrical parts inside the monitor.
 - Please check if the wall or ceiling can support the weight of the monitor before mounting it.

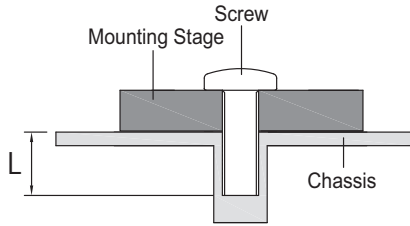

FITTING AND REMOVAL OF BASE

CAUTION

- Put the monitor on a stable surface. The monitor may cause injury or damage if it falls or is dropped.
- Do not give a strong impact to the monitor. It may cause damage.
- Unplug the monitor before removal or installation to avoid electric shock or damage.

<Installation>

- ① Put a piece of soft cloth on the table beforehand to prevent the monitor from being scratched. Lay the monitor flat on a table with front face down.
- ② Hold the monitor and push the Stand-Base.
- ③ Use 'thumb screw' provided to secure base to monitor column.

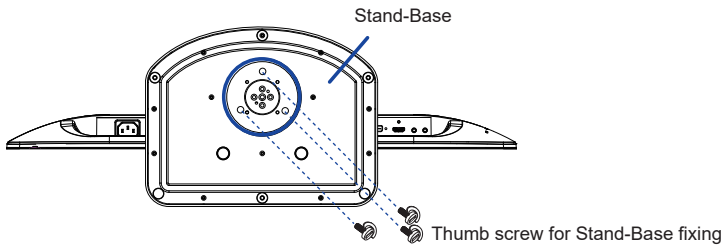

<Removal>

- ① Put a piece of soft cloth on the table beforehand to prevent the monitor from being scratched. Lay the monitor flat on a table with front face down.
- ② Remove 'thumb screw' to remove base from monitor column.

<Stopper>

Put the monitor on a flat surface. Press the stopper at the back of the stand while pushing the monitor from the top. Careful attention is required as the monitor is sprung loaded and the stand may expand quickly.

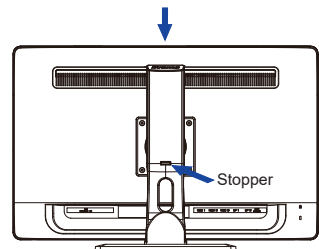

CONTROLS AND CONNECTORS

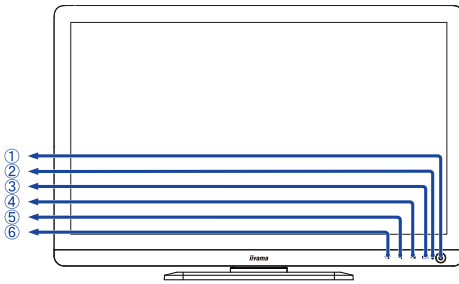



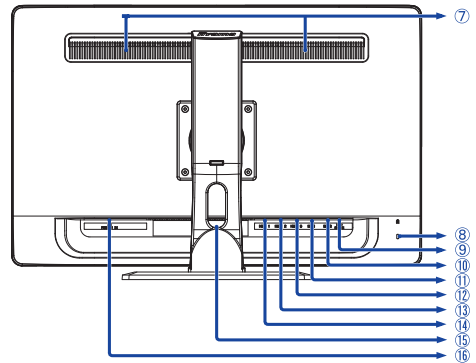

<Front>



<Back>

ENGLISH

- ① Power Switch ()
- ② Power Indicator
NOTE Blue: Normal operation
Orange: Power Management
- ③ Input / Select Button (INPUT/SELECT)*
- ④ Scroll up / Audio Adjust Button ( / )*
- ⑤ Scroll down / i-Style Color Button ( / )*
- ⑥ Menu / Exit Button (MENU/EXIT)
- ⑦ Speakers
- ⑧ Keyhole for Security Lock
NOTE You can fasten a security lock and cable to prevent the monitor from being removed without your permission.
- ⑨ Headphone Connector (EARPHONE)
- ⑩ DisplayPort Connector (DP2)
- ⑪ DisplayPort Connector (DP1)
- ⑫ HDMI Connector (HDMI3)
- ⑬ HDMI Connector (HDMI2)
- ⑭ HDMI Connector (HDMI1)
- ⑮ Cable Holes
- ⑯ AC Connector(~ : Alternating current) (AC POWER IN)

* You can skip the Menu items and display an adjustment scale directly.

CONNECTING YOUR MONITOR

- ① Ensure that both the computer and the monitor are switched off.
- ② Connect the computer to the monitor with the signal cable.
- ③ Connect the Power Cable to the monitor first and then to the power supply.
- ④ Turn on your monitor and computer.

NOTE

- The signal cables used for connecting the computer and monitor may vary with the type of computer used. An incorrect connection may cause serious damage to both the monitor and the computer. The cable supplied with the monitor is for a standard connector. If a special cable is required please contact your local iiyama dealer or regional iiyama office.
- For connection to Macintosh computers, contact your local iiyama dealer or regional iiyama office for a suitable adaptor.
- Make sure you tighten the finger screws at each end of the signal cable.
- The Class I pluggable equipment Type A must be connected to protective earth.
- The socket-outlet shall be installed near the equipment and shall be easily accessible.
- Excessive sound pressure from ear-/headphones can cause hearing damage/hearing loss.

[Example of Connection]

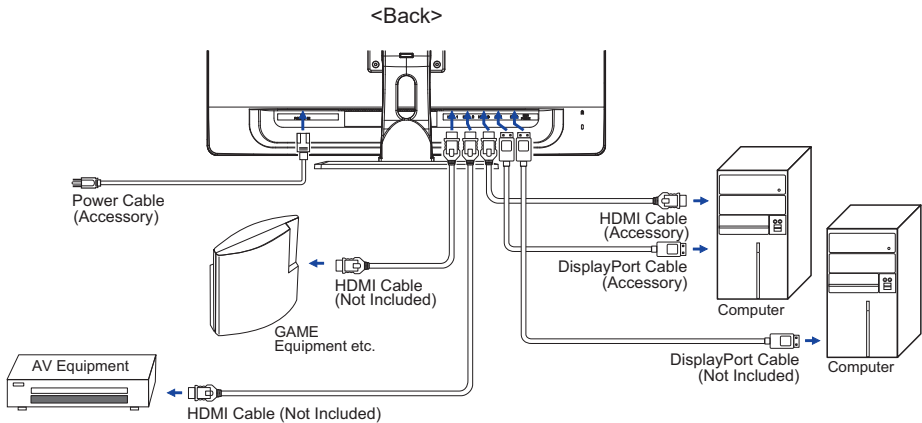

[Collect Cables]

- ① Put the cables through the cable hole.
- ② Collect cables at the back of the stand.

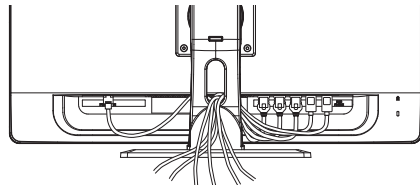

COMPUTER SETTING

■ Signal Timing

Change to the desired signal timing listed on page 24: COMPLIANT TIMING.

ADJUSTING THE HEIGHT AND THE VIEWING ANGLE

- For optimal viewing it is recommended to position yourself directly opposite to the full face of the monitor, then adjust the monitor's height and angle to your own preference.
- Hold the panel so that the monitor does not topple when you change the monitor's height or angle.
- You are able to adjust the monitor's height up to 130mm, angle up to 45 ° right and left, 17 ° upward and 2 ° downward.

NOTE

- Do not touch the LCD screen when you change the height or the angle. It may cause damage or break the LCD screen.
- Careful attention is required not to catch your fingers or hands when you change the height or the angle.
- Injury can occur if care is not taken to avoid finger contact with the displays base when adjusting the height.

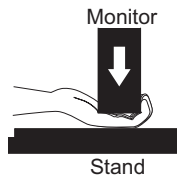
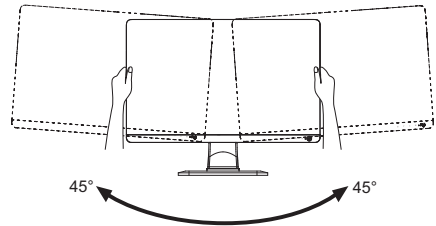
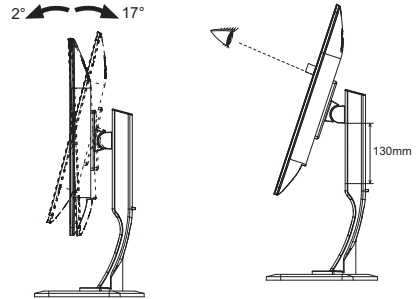

PANEL ROTATION

Not available on this model.

OPERATING THE MONITOR

To create the best picture, your iiyama LCD monitor has been preset at the factory with the COMPLIANT TIMING shown on page 24. You are also able to adjust the picture by following the button operation shown below.

- 1 Press the **MENU** Button to start the **On Screen Display (OSD)** feature. There are additional Menu items which can be switched by using the ◀/▶ Buttons.

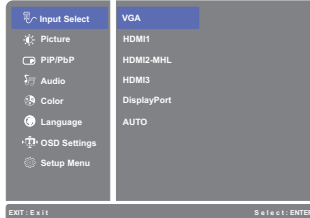

- 2 Select the Menu item which contains the adjustment icon relating to the adjustment you want to make. Press the **SELECT** Button. Then, use the ◀/▶ Buttons to highlight the desired adjustment icon.
- 3 Press the **SELECT** Button again. Use the ◀/▶ Buttons to make the appropriate adjustment or setting.
- 4 Press the **EXIT** Button to leave the menu, and the settings you just made would be automatically saved.

For example, to correct for OSD vertical position, select Menu item of  (OSD Settings) and then press the **SELECT** Button. Then, select OSD V. Position by using the ◀/▶ Buttons.

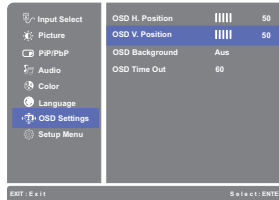

An adjustment page appears after you press the **SELECT** Button. Then, use the ◀/▶ Buttons to change the OSD vertical position settings. The OSD vertical position should be changing accordingly while you are doing this.



Press the **EXIT** Button lastly, it ends, all changes are saved in the memory.

NOTE

- When button operations are aborted during adjustment, On-Screen Display disappears when the time set for the OSD Time Out has passed. Also, press the **EXIT** button to quickly turn off the On-Screen Display.
- Any changes are automatically saved in the memory when the On Screen Display disappears. Turning off the power should be avoided while using the Menu.
- All adjustments have only one setting which applies to all signal timings.

■ Disabled function matrix

		After enabled function						
		Adv. Contrast	ECO Mode	i-Style Color	Blue Light Reducer	Brightness	Contrast	Overdrive
Function enabled	Adv. Contrast	—	×	○	×	×	○	○
	ECO Mode	×	—	○	×	×	○	○
	i-Style Color	×	×	—	×	×	×	×
	Blue Light Reducer	×	×	×	—	○	○	○

○ : adjustable

× : disabled

ADJUSTMENT MENU CONTENTS



Input Select

Direct

Adjustment Item	Problem / Option	Button to Press
Input Select	HDMI1	Select the HDMI1 input.
	HDMI2	Select the HDMI2 input.
	HDMI3	Select the HDMI3 input.
	DisplayPort1	Select the DisplayPort1 input.
	DisplayPort2	Select the DisplayPort2 input.
	AUTO	Search for an available input source and select automatically.



















NOTE

However it will automatically be selected when just one source is using. In Power Management Mode input switching is disabled. Input source is fixed, not selected automatically when HDMI1, HDMI2, HDMI3, DisplayPort1 and DisplayPort2 which are selected.

Direct

You can skip the Menu items and directly display an option setting screen by using the following button operations.

- Input Select: Press the INPUT when the Menu is not displayed.

 Picture			
Adjustment Item	Problem / Option		Button to Press
Picture Format * ¹	Full Screen	Full screen display	
	Aspect Ratio * ²	Expansion display of Aspect	
	Dot By Dot	Display the picture dot by dot.	
Brightness * ^{3,4}	Too dark		 
	Too bright		 
Contrast * ⁴	Too dull		 
	Too intense		 
Sharpness	<p>You can change the picture quality from 0 to 100 (soft to sharp). Press the  Button to change the picture quality in numerical order. Press the  Button to change the picture quality in reverse numerical order. Adjust the picture quality at resolutions of less than 3840 × 2160. You can change the picture quality.</p>		   
Overdrive * ^{1,4}	Off / -2 / -1 / 0 / +1 / +2 It will improve the gray level response time of the LCD panel. A higher level results in a faster response time.		   
Adv. Contrast * ^{1,4}	On	Increased Contrast Ratio	
	Off	Typical Contrast Ratio	
ECO Mode * ⁴	Off	Normal	
	1	Brightness of back-light is reduced.	
	2	Brightness of back-light is reduced more than 1.	
	3	Brightness of back-light is reduced more than 2.	
X-Res Technology	Off	Normal	
	Soft	Enhance the picture edge.	
	Middle	Enhance the picture edge more than the Soft option.	
	Hard	Enhance the picture edge more than the Middle option.	

*¹ Picture Format, Overdrive, Adv. Contrast are disabled when PiP/PbP Mode is activated.

*² Option unavailable with 16:9 resolution. When input video resolution is 4:3, 5:4 or 16:10, the image will be displayed in the center of the screen with 4:3 aspect ratio.

*³ Adjust the Brightness when you are using the monitor in a dark room and feel the screen is too bright.

*⁴ See page 11 for Disabled function matrix.

 PiP/PbP		
Adjustment Item	Problem / Option	Button to Press
PiP/PbP Mode *	Off	PiP/PbP Mode is turned off.
	PiP	Display the sub screen in the main screen.
	PbP	Divide display images in two
Sub Win Input	HDMI1	Select the HDMI1 input.
	HDMI2	Select the HDMI2 input.
	HDMI3	Select the HDMI3 input.
	DisplayPort1	Select the DisplayPort1 input.
	DisplayPort2	Select the DisplayPort2 input.
PiP Size	Small	Reduce the size of the Sub screen.
	Middle	Normal size
	Large	Increase the size of the Sub screen.
PiP Position	Top-Right	Move the sub screen to the top right corner.
	Top-Left	Move the sub screen to the top left corner.
	Bottom-Right	Move the sub screen to the bottom right corner.
	Bottom-Left	Move the sub screen to the bottom left corner.
Swap	Swaps the Main/Sub screens when PiP mode is active.	

* PiP = Picture In Picture

With this function, you can display two different pictures.

PbP = Picture By Picture

With this function, display images from two sources side by side.

Audio Direct	
Adjustment Item	Problem / Option Button to Press
Volume	Too soft Too loud ◀ ▶ ▶ ◀
Mute Direct	On Turn off the sound temporarily.
	Off Return the sound volume to the previous level.
Audio Input *	HDMI1 Select the HDMI1 input.
	HDMI2 Select the HDMI2 input.
	HDMI3 Select the HDMI3 input.
	DisplayPort1 Select the DisplayPort1 input.
	DisplayPort2 Select the DisplayPort2 input.





* When PiP or PbP is activated, you can select and use audio on the sub screen.

Direct

You can skip the Menu items and directly display an option setting screen by using the following button operations.

- Audio: Press the ▶ Button when the Menu is not displayed.
- Mute: Pressing and holding of the ▶ Button for about 2 seconds when the Menu is not displayed.

Mute and Unmute are switched as follows by pressing the ▶ Button successively.

 Color * ¹			
Adjustment Item	Problem / Option		Button to Press
Warm	Reddish white		
Normal	Greenish white		
Cool	Bluish white		
User Color	Red	Too weak	
	Green	Too strong	
	Blue		
i-Style Color Direct	Off	Return to a state set by color adjustment except i-Style Color.	
	Standard	For general windows environment and monitor default setting.	
	Scenery	For displaying outdoor scenery images	
	Cinema	For movie and video environment.	
	Text	For text editing and viewing in a word processing environment.	
Blue Light Reducer * ² Direct	Off	Typical	
	1	Blue light is reduced.	
	2	Blue light is reduced more than Mode1.	
	3	Blue light is reduced more than Mode2.	

*¹ Functions other than Blue Light Reducer is disabled when Blue Light Reducer is activated.













*² See page 11 for Disabled function matrix.

Direct

You can skip the Menu items and directly display an option setting screen by using the following button operations.

- i-Style Color : Press the  Button when the Menu is not displayed.
- Blue Light Reducer: Pressing and holding of the SELECT Button for about 2 seconds when the Menu is not displayed.

 Language				
Adjustment Item	Problem / Option			Button to Press
Language	English	English	Italiano	Italian
	Français	French	Русский	Russian
	Deutsch	German	日本語	Japanese
	Nederlands	Dutch	简体中文	Simplified Chinese
	Polski	Polish	繁體中文	Traditional Chinese
	Česky	Czech		

 OSD Settings		
Adjustment Item	Problem / Option	Button to Press
OSD H. Position	OSD is too left	 
	OSD is too right	 
OSD V. Position	OSD is too low	 
	OSD is too high	 
OSD Background	The background of OSD is made transparent. Off / 1 / 2 / 3 / 4	 
OSD Time Out	You can set the OSD display duration time. 5 / 10 / 20 / 30 / 60 seconds	 

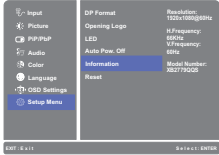
 Setup Menu			
Adjustment Item	Problem / Option		Button to Press
DP Format *	Limited	DisplayPort signal range is limited.	
	Full	Standard	
Opening Logo	On	iiyama Logo displayed when the monitor is turned on.	
	Off	iiyama Logo does not display when the monitor is turned on.	
LED	On	The Power Indicator is turned On.	
	Off	The Power Indicator is turned Off.	
NOTE Turn Off the Power Indicator when you are bothered by the light.			
Auto Pow. Off	On	Enable the Auto Pow. Off function.	
	Off	Auto Pow. Off function is turned Off.	
NOTE When the "Auto Pow. Off" function is enabled, the monitor will turn off automatically after 3 hours without any key operation.			
Information	Displays information regarding the current input signal coming from the graphic card in your computer. <Example>		
		NOTE See your graphic card user guide for more information about changing the resolution and refresh.	
Reset	Yes	Factory-preset data is restored.	
	No	Return to Menu.	

* When you select this option, the maximum supported resolution is 3840x2160 via the DisplayPort connection.

• Lock Mode

<OSD Menu>

1. The OSD lock will be activated by pressing the front buttons MENU and ► for about 5 seconds.
If you try to access the OSD by pressing any of the buttons MENU, ◀, ► and SELECT, message "OSD Locked" will appear on the screen.
2. The OSD lock will be deactivated by pressing the front buttons MENU and ► again for 5 seconds.

<Power Switch>

1. The power switch lock will be activated by pressing the front buttons MENU and ◀ for 5 seconds.
Locking the power switch means that won't be able to turn off the Monitor while the power switch is locked. If presses the power switch message "Power Button Locked" will appear on the screen.
2. The power switch lock will be deactivated by pressing the front buttons MENU and ◀ again for about 5 seconds.

POWER MANAGEMENT FEATURE

The power management feature of this product complies with power saving requirement of ENERGY STAR® and VESA DPMS. When activated, it automatically reduces unnecessary power consumption of the monitor when your computer is not in use.

To use the feature, the monitor needs to be connected to a VESA DPMS compliant computer. There is a power management step the monitor takes as described below. The power management function, including any timer settings is configured by the operating system. Check your operating system manual for information on how this can be configured.

■ Power Management Mode

When the H-sync signal / V-sync signal / H and V sync signals from the computer are off, the monitor enters into Power Management Mode which reduces the power consumption to less than 0.5W. The screen becomes dark, and the power indicator turns to orange. From Power Management Mode, the image reappears in several seconds when either the keyboard or the mouse are touched again.

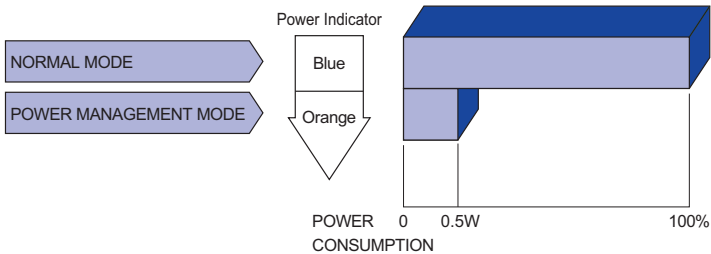

NOTE

- Even when using the power management mode, the monitor consumes electricity. Turn off the Power Switch whenever the monitor is not in use, during the night and weekends, to avoid unnecessary power consumption.
- It is possible that the video signal from the computer may be on while the H or V sync signal is missing. In this instance, the POWER MANAGEMENT feature may not work properly.

TROUBLE SHOOTING

If the monitor fails to operate correctly, please follow the steps below for a possible solution.

1. Perform the adjustments described in OPERATING THE MONITOR, depending on the problem you have. If the monitor does not get a picture, skip to 2.
2. Consult the following items if you cannot find an appropriate adjustment item in OPERATING THE MONITOR or if the problem persists.
3. If you are experiencing a problem which is not described below or you cannot correct the problem, discontinue using the monitor and contact your dealer or iiyama service center for further assistance.

Problem	Check
① The picture does not appear. (Power indicator does not light up.) (Power indicator is blue.) (Power indicator is orange.)	<input type="checkbox"/> The Power Cable is firmly seated in the socket. <input type="checkbox"/> The Power Switch is turned ON. <input type="checkbox"/> The AC socket is live. Please check with another piece of equipment. <input type="checkbox"/> If the blank screen saver is in active mode, touch the keyboard or the mouse. <input type="checkbox"/> Increase the Contrast and/or Brightness. <input type="checkbox"/> The computer is ON. <input type="checkbox"/> The Signal Cable is properly connected. <input type="checkbox"/> The signal timing of the computer is within the specification of the monitor. <input type="checkbox"/> If the monitor is in power management mode, touch the keyboard or the mouse. <input type="checkbox"/> The computer is ON. <input type="checkbox"/> The Signal Cable is properly connected. <input type="checkbox"/> The signal timing of the computer is within the specification of the monitor.
② The screen is not synchronized.	<input type="checkbox"/> The Signal Cable is properly connected. <input type="checkbox"/> The signal timing of the computer is within the specification of the monitor. <input type="checkbox"/> The video output level of the computer is within the specification of the monitor.
③ The screen position is not in the center.	<input type="checkbox"/> The signal timing of the computer is within the specification of the monitor.
④ The screen is too bright or too dark.	<input type="checkbox"/> The video output level of the computer is within the specification of the monitor.
⑤ The screen is shaking.	<input type="checkbox"/> The power voltage is within the specification of the monitor. <input type="checkbox"/> The signal timing of the computer is within the specification of the monitor.

Problem**Check**

- | | |
|---------------------------------------|--|
| ⑥ No sound. | <input type="checkbox"/> The audio equipment (computer etc.) is ON. |
| | <input type="checkbox"/> The Volume is turned up. |
| | <input type="checkbox"/> The Mute is OFF. |
| | <input type="checkbox"/> The audio output level of the audio equipment is within the specification of the monitor. |
| ⑦ The sound is too loud or too quiet. | <input type="checkbox"/> The audio output level of the audio equipment is within the specification of the monitor. |

RECYCLING INFORMATION

For better environment protection please don't dispose your monitor.
Please visit our web site: www.iiyama.com for monitor recycling.

APPENDIX

Design and specifications are subject to change without prior notice.

SPECIFICATIONS

Size Category		27"
LCD Panel	Panel technology	IPS
	Size	Diagonal: 27" (68.3cm)
	Pixel pitch	0.116mm H × 0.116mm V
	Brightness	440cd/m ² (Typical)
	Contrast ratio	1200 : 1 (Typical), Adv. Contrast Function Available
	Viewable angle	Right / Left : 89 ° each, Up / Down: 89 ° each (Typical)
	Response time	4ms (Gray to Gray)
Display Colors		16,777,216
Sync Frequency		HDMI: Horizontal: 30.0-135.0kHz, Vertical: 24-30,55-75Hz DisplayPort : Horizontal: 30.0-180.0kHz, Vertical: 24-30,55-75Hz
Native Resolution		5120 × 2880, 14.7 MegaPixels
Supported max. resolution		HDMI : 3840 × 2160 60Hz DisplayPort: 5120 × 2880 60Hz
Input Connector		HDMI × 3, DisplayPort × 2
Plug & Play		VESA DDC2B™
Input Video Signal		Digital: HDMI, DisplayPort
Headphone Connector		ø 3.5mm mini jack (Stereo)
Speakers		2W × 2 (Stereo speakers)
Maximum Screen Size		595.2mm W × 334.8mm H / 23.4" W × 13.2" H
Power Source		100-240VAC, 50/60Hz, 1.3A
Power Consumption		60W typical, Power management mode: 0.5W maximum Energy Efficiency Class: D
Dimensions / Net Weight		650.0 × 434.5 - 564.5 × 230.0mm / 25.6 × 17.1 - 22.2 × 9.1" (W×H×D) 8.2kg / 18.1lbs
Tilt Angle		Upward: 17 °, Downward: 2 °, Left/Right: 45 ° each
Environmental Considerations		Operating: Temperature 5 to 35°C / 41 to 95°F Humidity 10 to 80% (No condensation) Storage: Temperature -20 to 60°C / -4 to 140°F Humidity 5 to 85% (No condensation)
Approvals		CE, TÜV-Bauart, VCCI, PSE, ENERGY STAR®

DIMENSIONS

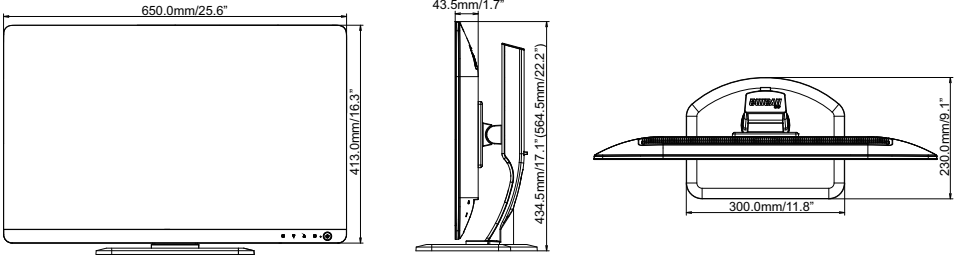

() : Maximum adjustment range

COMPLIANT TIMING

Video Mode	Horizontal Frequency	Vertical Frequency	Dot Clock	
640 × 480	31.469kHz	59.940Hz	25.175MHz	
	37.500kHz	75.000Hz	31.500MHz	
800 × 600	37.879kHz	60.317Hz	40.000MHz	
	46.875kHz	75.000Hz	49.500MHz	
1024 × 768	48.363kHz	60.004Hz	65.000MHz	
	60.023kHz	75.029Hz	78.750MHz	
1280 × 1024	63.981kHz	60.020Hz	108.000MHz	
	79.976kHz	75.025Hz	135.000MHz	
1680 × 1050	65.290kHz	60.000Hz	146.250MHz	
1920 × 1080	66.590kHz	59.930Hz	138.500MHz	
2560 × 1440	88.787kHz	59.951Hz	241.500MHz	
3840 × 2160	133.313kHz	59.997Hz	533.250MHz	
5120 × 2880	176.460kHz	59.960Hz	967.000MHz	*1
1920 × 2160	135.000kHz	60.000Hz	297.000MHz	*2

NOTE *1 DisplayPort input only.

*2 Recommended to use on PbP mode.