

# USER MANUAL

# *ProLite*

## LCD Monitor

ENGLISH

### *ProLite TF2738MSC*

Thank you very much for choosing the iiyama LCD monitor.

We recommend that you take a few minutes to read this comprehensive manual carefully before installing and switching on the monitor. Please keep this manual in a safe place for your future reference.



**Dear user, we congratulate you on the purchase of your iiyama LCD.**

For details on warranty and locally used pixel policies that apply directly after installation of your product please check the iiyama website.

**To report a fault, please contact your local support centre found at [www.iiyama.com/service](http://www.iiyama.com/service)**

### Things to check before you call the iiyama information line

- | if the power cable is connected securely and turned on?
- | if the display has been turned on?
- | if the signal cable is connected securely and the correct input selected?
- | if the computer has been restarted with the display connected?
- | if the graphics card is correctly installed with the latest drivers possible?
- | if the correct native resolution has been selected via 'Display Properties'?
- | If the R/G/B signal configuration is correct?
- | if the displays On Screen Menu is shown?
- | if the correct brightness and contrast settings have been set?
- | if given display tolerances and compatibility have been considered?
- | if via the On Screen Menu you have performed a Factory Reset/Recall?

### Before reporting the screen defect, please prepare the following information/evidence:

- | model number \*
- | purchase receipt and serial number \*
- | name and address for collection
- | telephone/fax number, for availability during the day
- | convenient collection date (date, time)
- | short description of the defect

### Important Note:

If there is no fault found in the collected equipment after inspection, the transferring party shall incur charges for transport and administration.

If you have checked all of the above and there is still no picture, call our information line for assistance in your country.

\* see the identification plate on the back of the case.

## CE MARKING DECLARATION OF CONFORMITY

This LCD monitor complies with the requirements of the EC/EU Directive 2014/30/EU "EMC Directive", 2014/35/EU "Low Voltage Directive", 2009/125/EC "ErP Directive" and 2011/65/EU "RoHS Directive".

The electro-magnetic susceptibility has been chosen at a level that gives correct operation in residential areas, business and light industrial premises and small-scale enterprises, inside as well as outside of the buildings. All places of operation are characterised by their connection to the public low voltage power supply system.

IYAMA CORPORATION: Wijkmeerstraat 8, 2131 HA Hoofddorp, The Netherlands

Model No. : PL2738M



We recommend recycling of used product. Please contact your dealer or iiyama service center. Recycle information is obtained via the Internet, using the address: <http://www.iiyama.com>

You can access the Web page of different countries from there.

- We reserve the right to change specifications without notice.
- All trademarks used in this user manual are the property of their respective owners.

# TABLE OF CONTENTS

FOR YOUR SAFETY .....	1
SAFETY PRECAUTIONS.....	1
SPECIAL NOTES ON LCD MONITORS .....	3
CUSTOMER SERVICE .....	3
CLEANING .....	3
BEFORE YOU OPERATE THE MONITOR .....	4
FEATURES.....	4
CHECKING THE CONTENTS OF THE PACKAGE .....	4
WALL MOUNTING .....	5
BUILT-IN EQUIPMENT.....	5
CONTROLS AND CONNECTORS.....	6
CONNECTING YOUR MONITOR.....	7
COMPUTER SETTING .....	9
OPERATING THE MONITOR.....	11
ADJUSTMENT MENU CONTENTS.....	12
POWER MANAGEMENT FEATURE.....	18
TROUBLE SHOOTING .....	19
RECYCLING INFORMATION.....	20
APPENDIX .....	21
SPECIFICATIONS.....	21
DIMENSIONS.....	22
COMPLIANT TIMING .....	22

# FOR YOUR SAFETY

## SAFETY PRECAUTIONS

### WARNING

#### **STOP OPERATING THE MONITOR IF YOU ARE AWARE OF ANY PROBLEMS**

If you notice any abnormal phenomena such as smoke, strange sounds or fumes, unplug the monitor and contact your dealer or iiyama service center immediately. Further use may be dangerous and can cause fire or electric shock.

#### **NEVER REMOVE THE CABINET**

High voltage circuits are inside the monitor. Removing the cabinet may expose you to the danger of fire or electric shock.

#### **DO NOT PUT ANY OBJECT INTO THE MONITOR**

Do not put any solid objects or liquids such as water into the monitor. In case of an accident, unplug your monitor immediately and contact your dealer or iiyama service center. Using the monitor with any object inside may cause fire, electric shock or damage.

#### **INSTALL THE MONITOR ON A FLAT, STABLE SURFACE**

The monitor may cause an injury if it falls or is dropped.

#### **DO NOT USE THE MONITOR NEAR WATER**

Do not use where water may be splashed or spilt onto the monitor as it may cause fire or electric shock.

#### **OPERATE UNDER THE SPECIFIED POWER SUPPLY**

Be sure to operate the monitor only with the specified power supply. Use of an incorrect voltage will cause malfunction and may cause fire or electric shock.

#### **PROTECT THE CABLES**

Do not pull or bend the power cable and signal cable. Do not place the monitor or any other heavy objects on the cables. If damaged, the cables may cause fire or electric shock.

#### **ADVERSE WEATHER CONDITIONS**

It is advisable not to operate the monitor during a heavy thunder storm as the continual breaks in power may cause malfunction. It is also advised not to touch the plug in these circumstances as it may cause electric shock.

## CAUTION

### INSTALLATION LOCATION

Do not install the monitor where sudden temperature changes may occur, or in humid, dusty or smoky areas as it may cause fire, electric shock or damage. You should also avoid areas where the sun shines directly on the monitor.

### DO NOT PLACE THE MONITOR IN A HAZARDOUS POSITION

The monitor may topple and cause injury if not suitably located. Please also ensure that you do not place any heavy objects on the monitor, and that all cables are routed such that children may not pull the cables and possibly cause injury.

### MAINTAIN GOOD VENTILATION

Ventilation slots are provided to keep the monitor from overheating. Covering the slots may cause fire. To allow adequate air circulation, place the monitor at least 10 cm (or 4 inches) from any walls. Operating the monitor on its back, side, upside down or on a carpet or any other soft material may also cause damage.

### DISCONNECT THE CABLES WHEN YOU MOVE THE MONITOR

When you move the monitor, turn off the power switch, unplug the monitor and be sure the signal cable is disconnected. If you do not disconnect them, it may cause fire or electric shock.

### UNPLUG THE MONITOR

If the monitor is not in use for a long period of time it is recommended that it is left unplugged to avoid accidents.

### HOLD THE PLUG WHEN DISCONNECTING

To disconnect the power cable or signal cable, always pull it by the plug. Never pull on the cable itself as this may cause fire or electric shock.

### DO NOT TOUCH THE PLUG WITH WET HANDS

Pulling or inserting the plug with wet hands may cause electric shock.

### WHEN YOU INSTALL THE MONITOR ON YOUR COMPUTER

Be sure the computer is strong enough to hold the weight of the monitor, otherwise, you may damage your computer.

### REMARK FOR 24/7 USAGE

This product is not specifically designed for 24/7 usage in all environments.

## OTHERS

### ERGONOMIC RECOMMENDATIONS

To eliminate eye fatigue, do not operate the monitor against a bright background or in a dark room. For optimal viewing comfort, the monitor should be just below eye level and 40-60 cm (16-24 inches) away from your eyes. When using the monitor over a prolonged time, a ten minute break every hour is recommended as looking at the screen continuously can cause eye strain.

## SPECIAL NOTES ON LCD MONITORS

The following symptoms are normal with LCD monitors and do not indicate a problem.

- NOTE**
- When you first turn on the LCD monitor, the picture may not fit in the display area because of the type of computer that is used. In this case, adjust the picture position to the correct position.
  - You may find slightly uneven brightness on the screen depending on the desktop pattern you use.
  - Due to the nature of the LCD screen, an afterimage of the previous screen may remain after switching the image, when the same image is displayed for hours. In this case, the screen can be recovered slowly by changing the image or turning off the Power Switch for some hours.

## CUSTOMER SERVICE

- NOTE**
- If you have to return your unit for service and the original packaging has been discarded, please contact your dealer or iiyama service center for advice or replacement packaging.

## CLEANING

- WARNING**
- If you drop any materials or liquids such as water into the monitor when cleaning, unplug the power cable immediately and contact your dealer or iiyama service center.
- CAUTION**
- For safety reasons, turn off the power switch and unplug the monitor before you clean it.
- NOTE**
- To protect the LCD panel, do not scratch or rub the screen with a hard object.
  - Never use any of the following strong solvents. These will damage the cabinet and the LCD screen.
- |                  |                          |
|------------------|--------------------------|
| Thinner          | Spray-type cleaner       |
| Benzine          | Wax                      |
| Abrasive cleaner | Acid or Alkaline solvent |
- Touching the cabinet with any product made from rubber or plastic for a long time may cause degeneration or loss of paint on the cabinet.

**CABINET** Stains can be removed with a cloth lightly moistened with a mild detergent solvent. Then wipe the cabinet with a soft dry cloth.

**LCD SCREEN** Periodic cleaning with a soft dry cloth is recommended.  
Don't use tissue paper etc. because these will damage the LCD screen.

## BEFORE YOU OPERATE THE MONITOR

### FEATURES

- ◆ Supports Resolutions up to 1920 × 1080
- ◆ High Contrast 3000:1 (Typical) / Brightness 300cd/m<sup>2</sup> (Typical), 255cd/m<sup>2</sup> (with Touch panel)
- ◆ Digital Character Smoothing
- ◆ Automatic Set-up
- ◆ Stereo Speakers  
2 × 3W Stereo Speakers
- ◆ Plug & Play VESA DDC2B Compliant  
Windows<sup>®</sup> 7/8.1/10 Compliant
- ◆ Power Management (VESA DPMS Compliant)
- ◆ VESA Mounting Standard (200mm×100mm, 100mm×100mm) Compliant
- ◆ IPX1 Standard Compliant (Only front face)

### CHECKING THE CONTENTS OF THE PACKAGE

The following accessories are included in your package. Check to see if they are enclosed with the monitor. If anything is missing or damaged, please contact your local iiyama dealer or regional iiyama office.

- |                |                     |                     |
|----------------|---------------------|---------------------|
| ■ Power Cable* | ■ HDMI Cable        | ■ DisplayPort Cable |
| ■ mDP-DP Cable | ■ USB Cable         | ■ Cable Cover       |
| ■ Safety Guide | ■ Quick Start Guide |                     |

#### **CAUTION** \* TO USERS IN 120V AREA

The rating of the Power Cable enclosed in 120V area is 10A/125V. If you are using a power supply higher than this rating, then a power cable with a rating of 10A/250V must be used. However, all guarantees and warranties are void for any problems or damage caused by a power cable or AC adapter not supplied by iiyama.

An approved power cable greater or equal to H05VVF, 3G, 0.75mm<sup>2</sup> must be used.



## WALL MOUNTING

**WARNING** When you use with the wall mounting, in consideration of thickness of the mounting stage, tighten the M4 Screws (4 pcs) with washer which "L" length is 8mm(VESA mounting holes) or 8mm(Outer mounting holes) to fasten the monitor. Using the screw longer than this may cause electric shock or damage because it may contact with the electrical parts inside the monitor.

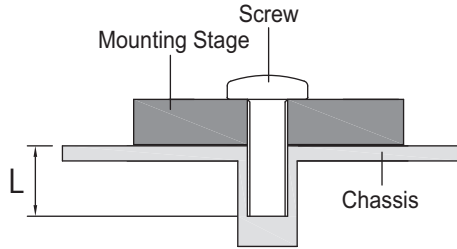

## BUILT-IN EQUIPMENT

**WARNING** This product is not designed for the purpose of being used in high temperature environment. If the product is placed in an external cabinet, you need to design cooling fans and vents to keep the temperature low enough to fit in the product temperature specification.

## CONTROLS AND CONNECTORS

ENGLISH

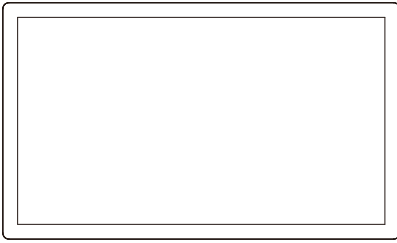

<Front>

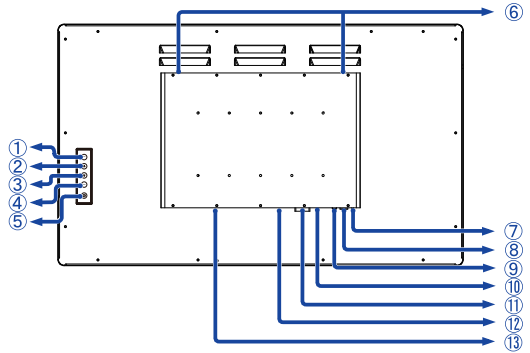

<Back>

- ① Menu Button (MENU)
- ② Scroll Up / Audio Adjust Button (  $\Delta$  )
- ③ Scroll Down / i-Style Color Button (  $\nabla$  )
- ④ Select / Input Select Button (ENTER)
- ⑤ Power Switch (  $\text{⏻}$  )
- ⑥ Speakers
- ⑦ Power Indicator
  - NOTE** Blue: Normal operation
  - Orange: Power Management
- ⑧ USB Connector (USB)
- ⑨ Audio Connector (AUDIO IN)
- ⑩ HDMI Connector (HDMI)
- ⑪ DVI-D Connector (DVI)
- ⑫ DisplayPort Connector (DP)
- ⑬ AC Connector (  $\sim$  : Alternating current) (AC POWER IN)

## CONNECTING YOUR MONITOR

- ① Ensure that both the computer and the monitor are switched off.
- ② Connect the computer to the monitor with the signal cable.
- ③ Connect the computer to the monitor with the USB Cable.
- ④ Connect the Power Cable to the monitor first and then to the power source.
- ⑤ Turn on your monitor and computer.

### NOTE

- The signal cables used for connecting the computer and monitor may vary with the type of computer used. An incorrect connection may cause serious damage to both the monitor and the computer. The cable supplied with the monitor is for a standard connector. If a special cable is required please contact your local iiyama dealer or regional iiyama office.
- For connection to Macintosh computers, contact your local iiyama dealer or regional iiyama office for a suitable adaptor.
- Make sure you tighten the finger screws at each end of the Signal Cable.
- The Class I pluggable equipment Type A must be connected to protective earth.
- The socket-outlet shall be installed near the equipment and shall be easily accessible.

[Example of Connection]

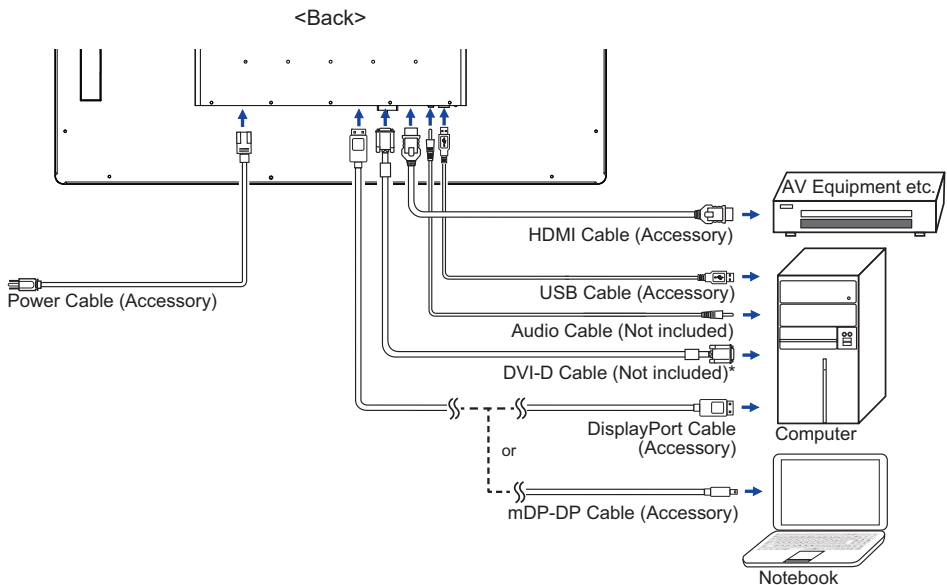

\* DVI-D cable is not supplied with the monitor. If you use low quality DVI-D cable, it may cause a result of electro-magnetic interference. Please contact the iiyama Support Centre in your country if you wish to connect the monitor via the DVI input.

**[Fitting and Removal of Cable Cover]**

Put a piece of soft cloth on the table beforehand to prevent the monitor from being scratched. Lay the monitor flat on a table with front face down.

**< Fitting >**

- ① Remove the screw from the monitor as shown in Step1.
- ② Connect the cables, as shown in Step2, place the cable cover and fix it firmly using a screw.

Step 1

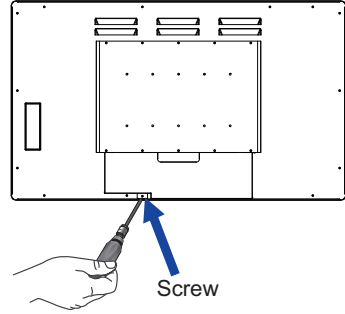

Step 2

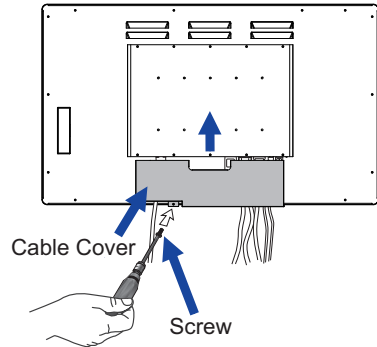
**< Removal >**

- ① Remove the screw and the cable cover as shown in Step3.

Step 3

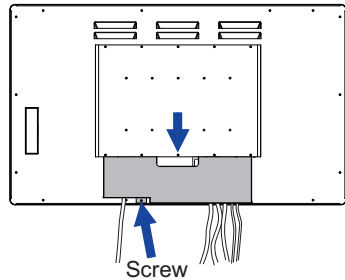

## COMPUTER SETTING

### ■ Signal Timing

Change to the desired signal timing listed on page 22: COMPLIANT TIMING.

### ■ TOUCH support operation system

	Mouse	Digitizer	Gestures * <sup>1</sup>	Remarks
Windows8/8.1/10	○	○	○	
Windows7	○	○	○	
Mac OS/OS X * <sup>2</sup>	○	○	○ * <sup>3</sup>	For Mac OS X version 10.6 and above you need a driver. Works for single touch only.
Linux	○	○	○	Kernel 2.6.38 and above
Android * <sup>4</sup>	○	○	○	Kernel 2.6.38 and above
Functions	Click Drag Double-Click	Mouse function Right-Click Flick Visual feedback	Mouse & Digitizer functions Press & Tap, Rotate, Zoom-in/out	

The other OS Versions not listed are not supported.

○ : Supported × : Not supported

\*<sup>1</sup> Gestures can be supported by application programs.

\*<sup>2</sup> Please download the Mac driver from the following website.

<https://www.touch-base.com/oem/weida/>

And, please use the "V6" driver for this model.

\*<sup>3</sup> When you install the gesture driver ([http://touch-base.com/documentation/Gestures.htm#\\_Installation\\_and\\_running](http://touch-base.com/documentation/Gestures.htm#_Installation_and_running)), it can support 2 - 4 finger gesture (definition be Apple Inc.)

\*<sup>4</sup> As Android is very divers, check with your device manufacturer if your device supports the touch function (for software developers; the controller is PID: 2575/ VID: 0402)

\*<sup>5</sup> Windows XP / Vista are not supported by Microsoft anymore.

\*<sup>6</sup> Chrome OS is supported. Chrome OS is auto updating and based on the (latest) Linux kernel.

## ■ Touch Input Settings in Dual Screen Mode

① Connect the primary monitor to the computer first.

Set Control Panel > Hardware and Sound > Tablet PC Settings > Display > Setup.

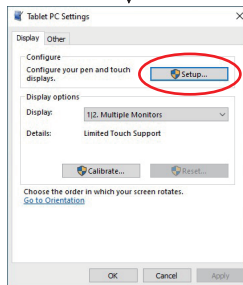
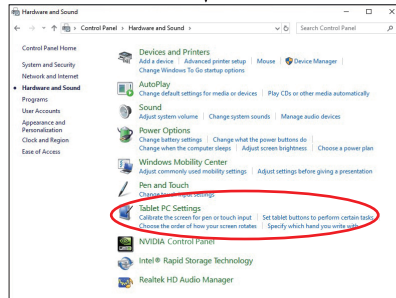
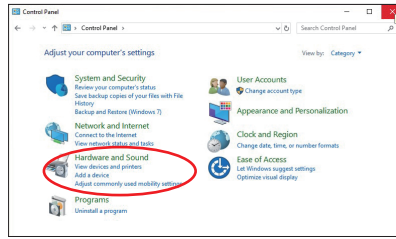

The following message will appear on the screen. Please follow the instructions.

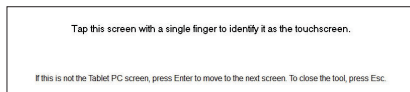

② After setting ①, connect a second monitor and perform the setup as in ①.

**NOTE** The monitors are recognized as dual-display, and touch operation cannot be performed on two monitors at the same time.

You can perform touch operation on only one of the monitors.

## OPERATING THE MONITOR

To create the best picture, your iiyama LCD monitor has been preset at the factory with the COMPLIANT TIMING shown on page 22. You are also able to adjust the picture by following the button operation shown below.

- 1 Press the ① Button to start the On Screen Display (OSD) feature. There are additional Menu items which can be switched by using the ▲ / ▼ Buttons.

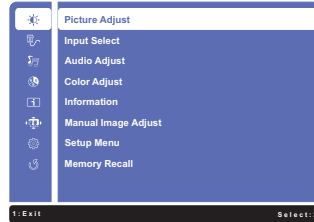

- 2 Select the Menu item which contains the adjustment icon relating to the adjustment you want to make. Press the ② Button. Then, use the ▲ / ▼ Buttons to highlight the desired adjustment icon.
- 3 Press the ② Button again. Use the ▲ / ▼ Buttons to make the appropriate adjustment or setting.
- 4 Press the ① Button to leave the menu, and the settings you just made would be automatically saved.

For example, to correct for the OSD vertical position, select Menu item of Setup Menu and then press the ② Button. Then, select the OSD Position by using the ▲ / ▼ Buttons.

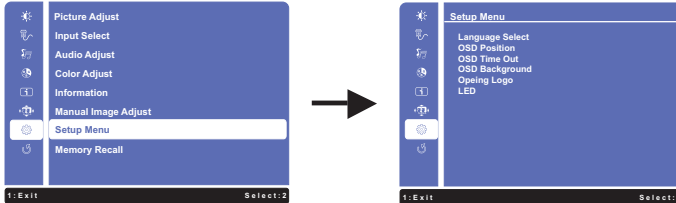

An adjustment page appears after you press the ② Button. Then, select OSD V.Position by using the ▲ / ▼ Buttons. Press the ② Button again. Then, use the ▲ / ▼ Buttons to change the OSD vertical position settings. The OSD vertical position of the overall display should be changing accordingly while you are doing this.

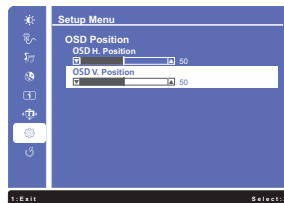













Press the ① Button lastly, it ends, all changes are saved in the memory.

### NOTE

- When button operations are aborted during adjustment, On-Screen Display disappears when the time set for the OSD Time Out has passed. Also, the ① button can be used to return previous menu and turn off the On-Screen Display.
- Any changes are automatically saved in the memory when the On Screen Display disappears. Turning off the power should be avoided while using the Menu.

## ADJUSTMENT MENU CONTENTS

Picture Adjust		 Picture Adjust	
Adjustment Item	Problem / Option		Button to Press
Contrast * <sup>3</sup>	Too dull		 
	Too intense		 
Brightness * <sup>1,2,3</sup>	Too dark		 
	Too bright		 
Adv. Contrast * <sup>2,3,4</sup>	Off	Typical Contrast Ratio	
	On	Increased Contrast Ratio	
ECO Mode * <sup>3</sup>	Off	Normal	
	1	Brightness of back-light is reduced.	
	2	Brightness of back-light is reduced more than 1.	
	3	Brightness of back-light is reduced more than 2.	
Overdrive * <sup>5,6</sup>	Off / -2 / -1 / 0 / +1 / +2		 
	It will improve the gray level response time of the LCD panel. A higher level results in a faster response time.		 

\*<sup>1</sup> Adjust the Brightness when you are using the monitor in a dark room and feel the screen is too bright. Can not select when Adv. Contrast is On.

\*<sup>2</sup> Brightness and Adv. Contrast can not enable the same time when ECO Mode is on.

\*<sup>3</sup> Contrast, Brightness, Adv. Contrast and ECO Mode adjustments are disabled when i-Style Color is activated.

\*<sup>4</sup> To activate the option, mark it in the setup menu. To deactivate it, remove the marking.

\*<sup>5</sup> Overdrive can only be enabled when the input refresh rate is 60Hz.

\*<sup>6</sup> Overdrive is disabled when Dot by Dot is activated.







Input Select <span style="float: right;"><b>Direct</b>  Input Select</span>		
Adjustment Item	Problem / Option <span style="float: right;">Button to Press</span>	
Input Select	DVI	Select the DVI input.
	HDMI	Select the HDMI input.
	DisplayPort	Select the DisplayPort input.
	Auto	Search for an available input source and select automatically.
<b>NOTE</b> Input source is fixed, not selected automatically when DVI, HDMI and DisplayPort which are selected.		

## Direct

You can skip the Menu items and directly display an option setting screen by using the following button operations.

- Input Select: Press the ② Button when the Menu is not displayed.

Audio Adjust <span style="float: right;"><b>Direct</b>  Audio Adjust</span>		
Adjustment Item	Problem / Option <span style="float: right;">Button to Press</span>	
Volume	Too soft <span style="float: right;"> </span> Too loud <span style="float: right;"> </span>	
Mute <sup>*1</sup> <span style="float: right;"><b>Direct</b></span>	Off	Return the sound volume to the previous level.
	On	Turn off the sound temporarily.
Audio Input <sup>*2</sup>	HDMI	Select the HDMI input.
	DisplayPort	Select the DisplayPort input.
	Line-In	Select the Line-In input.

<sup>\*1</sup> To activate the option, mark it in the setup menu. To deactivate it, remove the marking.

<sup>\*2</sup> Suitable for HDMI and DisplayPort input only.

## Direct

You can skip the Menu items and directly display an option setting screen by using the following button operations.

- Audio Adjust: Press the ▲ Button when the Menu is not displayed.
- Mute: Pressing and holding of the ▲ Button for about 2 seconds when the Menu is not displayed.  
Mute and Unmute are switched as follows by pressing the ▲ Button successively.

Color Adjust *		Color Adjust	
Adjustment Item	Problem / Option		Button to Press
Cool	Bluish white		
Normal	Greenish white		
Warm	Reddish white		
User Color	Red	Too weak	← ▲
	Green		
	Blue	Too strong	→ ▼
i-Style Color <b>Direct</b>	Off	Return to a state set by color adjustment except i-Style Color.	
	Standard	For general windows environment and monitor default setting.	
	Game	For PC game environment.	
	Cinema	For movie and video environment.	
	Scenery	For displaying outdoor scenery images	
	Text	For text editing and viewing in a word processing environment.	





\* Color Adjust is disabled when Blue Light Reducer is activated.

### Direct

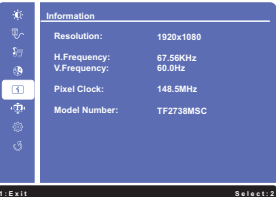
You can skip the Menu items and directly display an option setting screen by using the following button operations.

- i-Style Color: Press the ▼ Button when the Menu is not displayed.

Information		Information	
<p>&lt;Example&gt;</p> 		<p>Displays information regarding the current input signal coming from the graphic card in your computer.</p> <p><b>NOTE</b> See your graphic card user guide for more information about changing the resolution and refresh.</p>	

Manual Image Adjust		Manual Image Adjust	
Adjustment Item	Problem / Option		Button to Press
Sharpness	1 / 2 / 3 / 4 / 5		   
	<p>You can change the picture quality from 1 to 5 (soft to sharp). Press the ▲ Button to change the picture quality in numerical order. Press the ▼ Button to change the picture quality in reverse numerical order.</p> <p>Adjust the picture quality at resolutions of less 1920 x 1080. You can change the picture quality (5 steps).</p>		
Video Mode Adjust	Full Screen	Full screen display	
	Aspect Ratio * <sup>1</sup>	Expansion display of Aspect	
	Dot by Dot * <sup>3</sup>	Display the picture dot by dot.	
Blue Light Reducer * <sup>2</sup> <b>Direct</b>	Off	Typical	
	1	Blue light is reduced.	
	2	Blue light is reduced more than Mode1.	
	3	Blue light is reduced more than Mode2.	
X-res Technology	Off	Normal	
	Soft	Enhance the picture edge.	
	Middle	Enhance the picture edge more than the Soft option.	
	Hard	Enhance the picture edge more than the Middle option.	

\*<sup>1</sup> It can display in the center of the screen with a 4:3, 5:4 or 16:10 aspect ratio when input video resolution is 4:3, 5:4 or 16:10.











\*<sup>2</sup> Blue Light Reducer is disabled when Color Adjust is activated.

\*<sup>3</sup> Dot by Dot is disabled when Overdrive is activated.

### Direct

You can skip the Menu items and directly display an option setting screen by using the following button operations.

- Blue Light Reducer: Pressing and holding of the ② Button for about 2 seconds when the Menu is not displayed.

Setup Menu		Setup Menu		
Adjustment Item	Problem / Option			Button to Press
Language Select	English	English	Русский	Russian
	Français	French	日本語	Japanese
	Deutsch	German	简体中文	Simplified Chinese
	Nederlands	Dutch	繁體中文	Traditional Chinese
	Polski	Polish		
OSD Position	OSD H.Position	OSD is too left OSD is too right	 	 
	OSD V.Position	OSD is too low OSD is too high	 	 
OSD Time Out	You can set the OSD display duration time. 5 / 15 / 30 / 60 seconds			  
OSD Background*	Off	Retune the background of OSD.		
	On	The background of OSD is made transparent.		
Opening Logo*	Off	iiyama Logo does not display when the monitor is turned on.		
	On	iiyama Logo displayed when the monitor is turned on.		
LED*	Off	The Power Indicator is turned Off.		
	On	The Power Indicator is turned On.		
<b>NOTE</b> Turn Off the Power Indicator when you are bothered by the light.				

\* To activate the option, mark it in the setup menu. To deactivate it, remove the marking.

Memory Recall		Memory Recall	
Adjustment Item	Problem / Option		Button to Press
Memory Recall	Factory-preset data is restored.		

## • Lock Mode

### <OSD Menu>

1. The OSD lock will be activated by pressing the front buttons ① and ▲ for about 5 seconds. If you try to access the OSD by pressing any of the buttons ①, ▼, ▲ and ②, message "OSD Locked" will appear on the screen.
2. The OSD lock will be deactivated by pressing the front buttons ① and ▲ again for 5 seconds.

### <Power Switch>

1. The power switch lock will be activated by pressing the front buttons ① and ▼ for 5 seconds. Locking the power switch means that won't be able to turn off the Monitor while the power switch is locked. If presses the power switch message "Power Button Locked" will appear on the screen.
2. The power switch lock will be deactivated by pressing the front buttons ① and ▼ again for about 5 seconds.

## POWER MANAGEMENT FEATURE

The power management feature of this product complies with power saving requirement of VESA DPMS. When activated, it automatically reduces unnecessary power consumption of the monitor when your computer is not in use.

To use the feature, the monitor needs to be connected to a VESA DPMS compliant computer. There is a power management step the monitor takes as described below. The power management function, including any timer settings is configured by the operating system. Check your operating system manual for information on how this can be configured.

ENGLISH

### ■ Power Management Mode

When the video signal from the computer is off, the monitor enters into Power Management Mode which reduces the power consumption to less than 0.5W\*. The screen becomes dark, and the power indicator turns to orange. From Power Management Mode, the image reappears in several seconds when either the keyboard or the mouse are touched again.

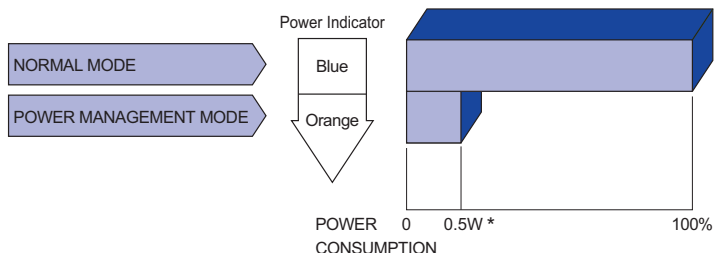

\* USB peripheral and audio equipment are not connected.

**NOTE** Even when using the power management mode, the monitor consumes electricity. Turn off the Power Switch whenever the monitor is not in use, during the night and weekends, to avoid unnecessary power consumption.

## TROUBLE SHOOTING

If the monitor fails to operate correctly, please follow the steps below for a possible solution.

1. Perform the adjustments described in OPERATING THE MONITOR, depending on the problem you have. If the monitor does not get a picture, skip to 2.
2. Consult the following items if you cannot find an appropriate adjustment item in OPERATING THE MONITOR or if the problem persists.
3. If you are experiencing a problem which is not described below or you cannot correct the problem, discontinue using the monitor and contact your dealer or iiyama service center for further assistance.

<b>Problem</b>	<b>Check</b>
① The picture does not appear. (Power indicator does not light up.)	<input type="checkbox"/> The Power Cable is firmly seated in the socket. <input type="checkbox"/> The Power Switch is turned ON. <input type="checkbox"/> The AC socket is live. Please check with another piece of equipment.
(Power indicator is blue.)	<input type="checkbox"/> If the blank screen saver is in active mode, touch the keyboard or the mouse. <input type="checkbox"/> Increase the Contrast and/or Brightness. <input type="checkbox"/> The computer is ON. <input type="checkbox"/> The Signal Cable is properly connected. <input type="checkbox"/> The signal timing of the computer is within the specification of the monitor.
(Power indicator is orange.)	<input type="checkbox"/> If the monitor is in power management mode, touch the keyboard or the mouse. <input type="checkbox"/> The computer is ON. <input type="checkbox"/> The Signal Cable is properly connected. <input type="checkbox"/> The signal timing of the computer is within the specification of the monitor.
② The screen is not synchronized.	<input type="checkbox"/> The Signal Cable is properly connected. <input type="checkbox"/> The signal timing of the computer is within the specification of the monitor. <input type="checkbox"/> The video output level of the computer is within the specification of the monitor.
③ The screen position is not in the center.	<input type="checkbox"/> The signal timing of the computer is within the specification of the monitor.
④ The screen is too bright or too dark.	<input type="checkbox"/> The video output level of the computer is within the specification of the monitor.
⑤ The screen is shaking.	<input type="checkbox"/> The power voltage is within the specification of the monitor. <input type="checkbox"/> The signal timing of the computer is within the specification of the monitor.
⑥ No sound.	<input type="checkbox"/> The audio equipment (computer etc.) is ON. <input type="checkbox"/> The Audio Cable is properly connected. <input type="checkbox"/> The Volume is turned up. <input type="checkbox"/> The Mute is OFF. <input type="checkbox"/> The audio output level of the audio equipment is within the specification of the monitor.
⑦ The sound is too loud or too quiet.	<input type="checkbox"/> The audio output level of the audio equipment is within the specification of the monitor.

**Problem****Check**

- |  |   |
|--|---|
| ⑧ A strange noise is heard.            | <input type="checkbox"/> The Audio Cable is properly connected.   |
| ⑨ The touch screen shows no response.  | <input type="checkbox"/> The USB Cable is firmly seated in the socket.<br><input type="checkbox"/> Touch screen driver software is installed. |
| ⑩ The touch position does not deviate. | <input type="checkbox"/> The calibration function set up correctly.   |

## RECYCLING INFORMATION

For better environment protection please don't dispose your monitor.  
Please visit our web site: [www.iiyama.com](http://www.iiyama.com) for monitor recycling.



## APPENDIX

Design and specifications are subject to change without prior notice.

### SPECIFICATIONS

Touch Screen	Technology	Projected capacitive 10pt touch
	Light transmission	85%
	Hardness	6H
	Total thickness	3.6mm
	Communication system	USB serial transfer
Size Category		27"
LCD Panel	Panel technology	AMVA+
	Size	Diagonal: 27" (68.6cm)
	Pixel pitch	0.31125mm H × 0.31125mm V
	Brightness	300cd/m <sup>2</sup> (Typical), 255cd/m <sup>2</sup> (with Touch panel)
	Contrast ratio	3000 : 1 (Typical: with Touch panel)
	Viewable angle	Right / Left : 89 degrees each, Up / Down: 89 degrees each (Typical)
	Response time	12ms (Typical), 5ms (Gray to Gray) <sup>*3</sup>
Display Colors		Approx. 16.7M
Sync Frequency		Horizontal: 30-80kHz, Vertical: 55-75Hz
Maximum Resolution		1920 × 1080, 2.1 MegaPixels
Input Connector		DVI-D, HDMI, DisplayPort
Plug & Play		VESA DDC2B™
Input Video Signal		Digital: DVI (Digital Visual Interface Standard Rev.1.0) compliance Digital: HDMI, DisplayPort
Input Audio Connector		ø 3.5mm mini jack (Stereo)
Input Audio Signal		1.0Vrms maximum
Speakers		3W × 2 (Stereo speakers)
Maximum Screen Size		597.6mm W × 336.2mm H / 23.5" W × 13.2" H
Power Source		100-240VAC, 50/60Hz 0.7A
Power Consumption <sup>*1</sup>		30W typical, Power management mode: 0.5W maximum Energy Efficiency Class: A
Dimensions / Net Weight		648.5 × 386.5 × 52.0mm / 25.5 × 15.2 × 2.0" (W×H×D) 7.7kg / 17.0lbs
Environmental Considerations		Operating: Temperature 5 to 35°C / 41 to 95°F Humidity 10 to 80% (No condensation) Storage: Temperature -20 to 60°C / -4 to 140°F Humidity 5 to 85% (No condensation)
Approvals		CE, TÜV-Bauart, cULus, EAC, CCC, IPX1 <sup>*2</sup>

**NOTE** <sup>\*1</sup> USB peripheral and audio equipment are not connected.

<sup>\*2</sup> IPX1 Standard Compliant : Only front face

<sup>\*3</sup> When set to Overdrive +2.

## DIMENSIONS

ENGLISH

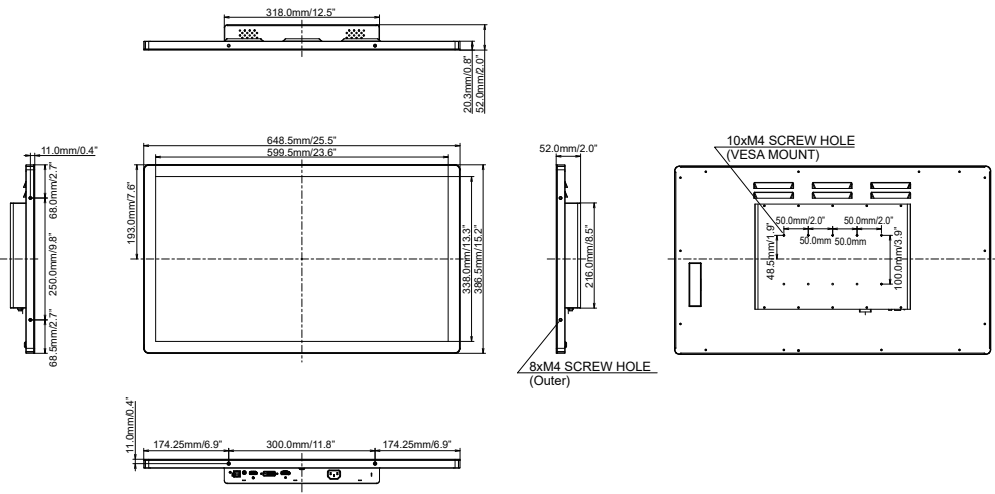

## COMPLIANT TIMING

Video Mode	Horizontal Frequency	Vertical Frequency	Dot Clock
640 × 480	31.469kHz	59.940Hz	25.175MHz
	37.500kHz	75.000Hz	31.500MHz
	37.861kHz	72.809Hz	31.500MHz
800 × 600	35.156kHz	56.250Hz	36.000MHz
	37.879kHz	60.317Hz	40.000MHz
	46.875kHz	75.000Hz	49.500MHz
	48.077kHz	72.188Hz	50.000MHz
1024 × 768	48.363kHz	60.004Hz	65.000MHz
	56.476kHz	70.069Hz	75.000MHz
	60.023kHz	75.029Hz	78.750MHz
1280 × 1024	63.981kHz	60.020Hz	108.000MHz
	79.976kHz	75.025Hz	135.000MHz
1440 × 900	55.935kHz	59.887Hz	106.500MHz
1680 × 1050	65.290kHz	60.000Hz	146.250MHz
1920 × 1080	66.590kHz	59.930Hz	138.500MHz