



ProLite T1731SR-1 is based on the latest 5 Wire Resistive technology. Price / performance ratio is ideal for the budget conscious user while quality and specification is certainly not compromised. The display inputs include both Analogue and Digital (DVI) with Touchscreen connectivity via either USB or RS-232 which offers greater than typical flexibility. A solid and steady base supports the TouchScreen with an adjustable stand offering full 90 degree angles. Extensive Touch Utilities allow for 4 point calibration and either 9/25 point linerization. An incredibly powerful Touch solution. Available in black and white.



### Touch technology - Resistive

5-wire resistive touchscreens are very durable and can be used in a variety of environments. They are especially recommended for shops, restaurants and industrial purposes.



### IP54

The IP Code classifies how resistant a device is to foreign objects and moisture. IP54 means that the monitor will operate in dusty conditions, and will resist splashing water.

## 01 DISPLAY CHARACTERISTICS

Diagonal	17", 43cm
Panel	TN LED
Native resolution	1280 x 1024 (1.3 megapixel)
Aspect ratio	5:4
Panel brightness	250 cd/m <sup>2</sup>
Brightness	200 cd/m <sup>2</sup> with touch
Light transmittance	80%
Static contrast	900:1 with touch
Response time (GTG)	5ms
Viewing zone	horizontal/vertical: 170°/160°, right/left: 85°/85°, up/down: 80°/80°
Colour support	16.7mln
Horizontal Sync	31.5 - 80kHz
Viewable area W x H	338 x 270mm, 13.3 x 10.6"
Pixel pitch	0.264mm
Bezel colour and finish	black, matte

## 02 TOUCH

Touch technology	serial resistive
Touch points	1
Touch method	stylus, finger, glove
Touch interface	USB
Supported operating systems	All iiyama monitors are Plug & Play and compatible with Windows and Linux. For details regarding the supported OS for the touch models, please refer to the driver instruction file available in the downloads section.

## 03 INTERFACES / CONNECTORS / CONTROLS

Analog signal input	VGA x1
Digital signal input	DVI x1
Audio output	Speakers 2 x 1W

## 04 FEATURES

Water and dust protection	IP54 (front)
OSD key lock	yes

## 05 GENERAL

OSD languages	EN, DE, FR, ES, IT, CN, JP
Control buttons	Menu, Scroll up/ Brightness, Scroll down/ Mute, Select/ Auto, Power
User controls	contrast, brightness, auto adjust, H.position, V.position, H.size, phase, OSD H.position, OSD V.position, OSD timeout, reset, input select, OSD language, colour temperature, volume, mute
Convenience	Kensington-lock™ prepared
Plug&Play	DDC2B

## 06 MECHANICAL

Tilt angle 90° up; 5° down

VESA mounting 100 x 100mm

Cable management system yes

## 07 ACCESSORIES INCLUDED

Cables power, VGA, DVI, USB, Audio

Guides quick start guide, safety guide

Other Touch Panel Driver Disk (CD-ROM)

Cable cover yes

## 08 POWER MANAGEMENT

Power supply unit internal

Power supply AC 100 - 240V, 50/60Hz

Power usage 20W typical, 2W stand by, 2W off mode

## 09 SUSTAINABILITY

Regulations CB, CE, TÜV-Bauart, GOST, RoHS support, ErP, WEEE, VCCI, REACH

REACH SVHC above 0.1%: Lead

## 10 DIMENSIONS / WEIGHT

Product dimensions W x H x D 387 x 342 x 201mm

Weight (without box) 5.8kg

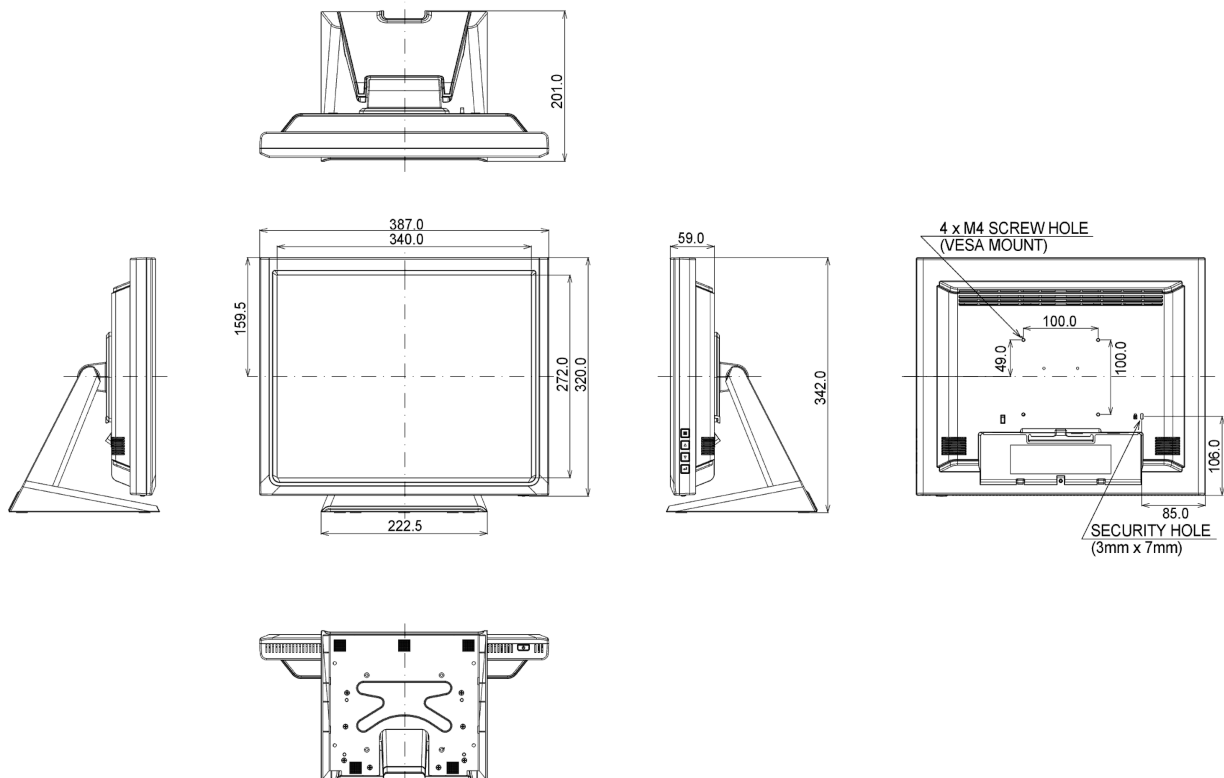

*All trademarks and registered trademarks acknowledged. E & O E. Specification subject to change without notice. All LCD's comply with ISO-9241-307:2008 in connection with pixel defects.*

© IYAMA CORPORATION. ALL RIGHTS RESERVED