

# USER MANUAL

# *ProLite*

## LCD Monitor

ENGLISH

### *ProLite S2820HSB*

Thank you very much for choosing the iiyama LCD monitor.

We recommend that you take a few minutes to read this comprehensive manual carefully before installing and switching on the monitor. Please keep this manual in a safe place for your future reference.

## CE MARKING DECLARATION OF CONFORMITY

This LCD monitor complies with the requirements of the EC/EU Directive 2014/30/EU "EMC Directive", 2014/35/EU "Low Voltage Directive" and 2011/65/EU "RoHS Directive".

### Warning

This is a class A product. In a domestic environment this product may cause radio interference in which case the user may be required to take adequate measures.

IYAMA CORPORATION: Wijkemeerstraat 8, 2131 HA Hoofddorp, The Netherlands

Model No. : PL2820HB



We recommend recycling of used product. Please contact your dealer or iiyama service center. Recycle information is obtained via the Internet, using the address: <http://www.iiyama.com>

You can access the Web page of different countries from there.

- We reserve the right to change specifications without notice.
- All trademarks used in this user manual are the property of their respective owners.

# TABLE OF CONTENTS

FOR YOUR SAFETY.....	1
SAFETY PRECAUTIONS.....	1
SPECIAL NOTES ON LCD MONITORS .....	3
CUSTOMER SERVICE .....	5
CLEANING .....	5
BEFORE YOU OPERATE THE MONITOR.....	6
FEATURES.....	6
CHECKING THE CONTENTS OF THE PACKAGE .....	6
CONTROLS AND CONNECTORS : MONITOR.....	7
INSTALLATION .....	9
CONNECTING YOUR MONITOR.....	11
COMPUTER SETTING .....	12
OPERATING THE MONITOR.....	13
ADJUSTMENT MENU CONTENTS.....	15
SCREEN ADJUSTMENTS .....	22
TROUBLE SHOOTING .....	25
RECYCLING INFORMATION.....	26
APPENDIX .....	27
SPECIFICATIONS : ProLite S2820HSB .....	27
DIMENSIONS : ProLite S2820HSB .....	28
COMPLIANT TIMING .....	28

# FOR YOUR SAFETY

## SAFETY PRECAUTIONS

### WARNING

#### **STOP OPERATING THE MONITOR WHEN YOU SENSE TROUBLE**

If you notice any abnormal phenomena such as smoke, strange sounds or fumes, unplug the monitor and contact your dealer or iiyama service center immediately. Further use may be dangerous and can cause fire or electric shock.

#### **NEVER REMOVE THE CABINET**

High voltage circuits are inside the monitor. Removing the cabinet may expose you to the danger of fire or electric shock.

#### **DO NOT PUT ANY OBJECT INTO THE MONITOR**

Do not put any solid objects or liquids such as water into the monitor. In case of an accident, unplug your monitor immediately and contact your dealer or iiyama service center. Using the monitor with any object inside may cause fire, electric shock or damage.

#### **INSTALL THE MONITOR ON A FLAT, STABLE SURFACE**

The monitor may cause an injury if it falls or is dropped.

#### **DO NOT USE THE MONITOR NEAR WATER**

Do not use where water may be splashed or spilt onto the monitor as it may cause fire or electric shock.

#### **OPERATE UNDER THE SPECIFIED POWER SUPPLY**

Be sure to operate the monitor only with the specified power supply. Use of an incorrect voltage will cause malfunction and may cause fire or electric shock.

#### **PROTECT THE CABLES**

Do not pull or bend the power cable and signal cable. Do not place the monitor or any other heavy objects on the cables. If damaged, the cables may cause fire or electric shock.

#### **ADVERSE WEATHER CONDITIONS**

It is advisable not to operate the monitor during a heavy thunder storm as the continual breaks in power may cause malfunction. It is also advised not to touch the plug in these circumstances as it may cause electric shock.

## CAUTION

### INSTALLATION LOCATION

Do not install the monitor where sudden temperature changes may occur, or in humid, dusty or smoky areas as it may cause fire, electric shock or damage. You should also avoid areas where the sun shines directly on the monitor.

### DO NOT PLACE THE MONITOR IN A HAZARDOUS POSITION

The monitor may topple and cause injury if not suitably located. Please also ensure that you do not place any heavy objects on the monitor, and that all cables are routed such that children may not pull the cables and possibly cause injury.

### MAINTAIN GOOD VENTILATION

Ventilation slots are provided to keep the monitor from overheating. Covering the slots may cause fire. To allow adequate air circulation, place the monitor at least 10 cm (or 4 inches) from any walls. Operating the monitor on its back, side, upside down or on a carpet or any other soft material may also cause damage.

### DISCONNECT THE CABLES WHEN YOU MOVE THE MONITOR

When you move the monitor, turn off the power switch, unplug the monitor and be sure the signal cable is disconnected. If you do not disconnect them, it may cause fire or electric shock.

### UNPLUG THE MONITOR

If the monitor is not in use for a long period of time it is recommended that it is left unplugged to avoid accidents.

### HOLD THE PLUG WHEN DISCONNECTING

To disconnect the power cable or signal cable, always pull it by the plug. Never pull on the cable itself as this may cause fire or electric shock.

### DO NOT TOUCH THE PLUG WITH WET HANDS

Pulling or inserting the plug with wet hands may cause electric shock.

### WHEN YOU INSTALL THE MONITOR ON YOUR COMPUTER

Be sure the computer is strong enough to hold the weight of the monitor, otherwise, you may damage your computer.

## OTHERS

### ERGONOMIC RECOMMENDATIONS

To eliminate eye fatigue, do not operate the monitor against a bright background or in a dark room. For optimal viewing comfort, the monitor should be just below eye level and 40-60 cm (16-24 inches) away from your eyes. When using the monitor over a prolonged time, a ten minute break every hour is recommended as looking at the screen continuously can cause eye strain.

## SPECIAL NOTES ON LCD MONITORS

- The following symptoms are normal with LCD monitors and do not indicate a problem.

### NOTE

- When you first turn on the LCD monitor, the picture may not fit in the display area because of the type of computer that is used. In this case, adjust the picture position to the correct position.
  - You may find slightly uneven brightness on the screen depending on the desktop pattern you use.
  - Due to the nature of the LCD screen, an afterimage of the previous screen may remain after switching the image, when the same image is displayed for hours. In this case, the screen is recovered slowly by changing the image or turning off the Power Switch for hours.
- This LCD cannot be used outdoors.
  - This LCD cannot be used with the screen facing upwards.
  - If you use a cable longer than the supplied one, the picture quality is not guaranteed.

## USAGE CONFIRMATION

This product is designed for optimum usage at 24hours per day.  
The display is compatible for usage in Landscape/Portrait applications.

## IMAGE PERSISTENCE / IMAGE STICKING

Please be aware that all LCD screens can experience Image Persistence or Image Sticking. This occurs when a residual image remains visible on a screen when static images are displayed for long periods of time. LCD Image Persistence is not permanent but constant images being displayed for a long period of time should be avoided.

To counteract Image Persistence, turn off the monitor for as long as the previous image was displayed, so if an image was on the monitor for 1 hour and there is evidence of a residual or “ghost” image, you should turn off the monitor for 1 hour in order to clear the residual image.

For all LFD products, iiyama recommends displaying moving images and utilising a moving screen saver at regular intervals whenever the screen is idle. You could also turn off the monitor when not in use to assist the prevention.

Other ways to reduce the risk of Image Persistence will be to utilise the FAN-on function (if available), Low Backlight and Low Brightness settings.

## FOR EXTENDED USE AS A PUBLIC DISPLAY

### ■ Image Sticking on LCD Panel

When a static image is displayed for hours, an electric charge trace remains near the electrode inside the LCD producing a “ghost” image. (Image Persistence).

Image Persistence is not a permanent feature.

### ■ Recommendations

To prevent Image Sticking and promote longer life expectancy of display, we recommend the following:

1. Avoid static images displayed for long periods – change static images on continuous loop.
2. Turn off monitor when not in use, either by remote control or use Power Management or Schedule functions.
3. When monitor is installed in high ambient temperature environment(s) or in an enclosed position, utilise the Cooling Fan, Screen Saver and Low Brightness functions.
4. Suitable ventilation for any monitor is an expectation of any installation – climate control systems may need to be employed.
5. We strongly recommend utilisation of active cooling with fans for long operation times or high ambient temperature environments.

## CUSTOMER SERVICE

### NOTE

- If you have to return your unit for service and the original packaging has been discarded, please contact your dealer or iiyama service center for advice or replacement packaging.

## CLEANING

### WARNING

- If you drop any materials or liquids such as water into the monitor when cleaning, unplug the power cable immediately and contact your dealer or iiyama service center.

### CAUTION

- For safety reasons, turn off the power switch and unplug the monitor before you clean it.

### NOTE

- To protect the LCD panel, do not scratch or rub the screen with a hard object.
- Never use any of the following strong solvents. These will damage the cabinet and the LCD screen.

Thinner	Benzine	Abrasive cleaner
Spray-type cleaner	Wax	Acid or Alkaline solvent

- Touching the cabinet with any product made from rubber or plastic for a long time may cause degeneration or loss of paint on the cabinet.

### CABINET

Stains can be removed with a cloth lightly moistened with a mild detergent solvent. Then wipe the cabinet with a soft dry cloth.

### LCD

Periodic cleaning with a soft dry cloth is recommended.

### SCREEN

Don't use tissue paper etc. because these will damage the LCD screen.



# BEFORE YOU OPERATE THE MONITOR

## FEATURES

- ◆ Supports Resolutions up to 1920 × 360
- ◆ High Contrast 1000:1 (Typical) / Brightness 1000cd/m<sup>2</sup> (Typical)
- ◆ Automatic Set-up
- ◆ Stereo Speakers  
2 × 5W Stereo Speakers
- ◆ Plug & Play VESA DDC2B Compliant  
Windows<sup>®</sup> 7/8.1/10 Compliant
- ◆ Power Management (VESA DPMS Compliant)
- ◆ VESA Mounting Standard (400mm×75mm, 75mm×75mm) Compliant
- ◆ Support 24hrs/day usage (by moving picture condition)

## CHECKING THE CONTENTS OF THE PACKAGE

The following accessories are included in your package. Check to see if they are enclosed with the monitor. If anything is missing or damaged, please contact your local iiyama dealer or regional iiyama office.

- Power Cable\*
- AC Adapter\*
- HDMI Cable
- RS-232C Cable
- Light Sensor Cable
- Safety Guide
- Quick Start Guide

### CAUTION \* 1. TO USERS IN 120V AREA

The rating of the Power Cable enclosed in 120V area is 10A/125V. If you are using a power supply higher than this rating, then a power cable with a rating of 10A/250V must be used.

However, all guarantees and warranties are void for any problems or damage caused by a power cable or AC adapter not supplied by iiyama.

#### 2. Applicable AC Adapter

AC Adapter Type Name : 2ABF060F (Channel Well Technology Co., Ltd.)

#### 3. An approved power cable greater or equal to H05VVf, 3G, 0.75mm<sup>2</sup> must be used.

## CONTROLS AND CONNECTORS : MONITOR

### <Top Controller>

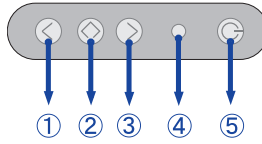

①	<	Decrease / Brightness Button	
②	◇	Menu / Enter Button	
③	>	Increase / Input Select Button	
④	Power Indicator	Green	Normal Operation
		Red	Power Management
		Off	Power Off
⑤	⏻	Power Button	

### <Front>

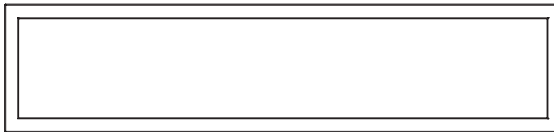

<Back>

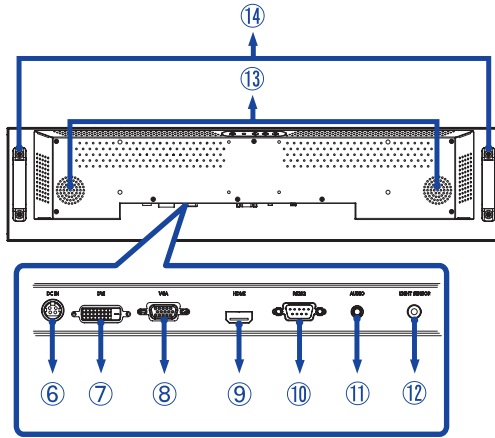

⑥	DC IN	DC jack	Connector for AC Adapter(--- : Direct current) (DC-IN)
⑦	DVI	DVI-D	DVI-D Connector
⑧	VGA	VGA	VGA Connector
⑨	HDMI	HDMI	HDMI Connector
⑩	RS232	RS-232C 9pin	RS-232C Connector
⑪	AUDIO IN (PC Audio In)	Mini Jack	Audio Connector
⑫	LIGHT SENSOR	Light Sensor	Light Sensor Connector
⑬	SPEAKERS		Speakers
⑭	HANDLES		Handles

## INSTALLATION

### CAUTION

- Follow the manual instructions for the type of mount you have selected. Refer all servicing to qualified service personnel.
- Moving the monitor requires at least two people.
- Before installing, please make sure the wall is strong enough to hold the necessary weight of the display and the mount.

### [WALL MOUNTING]

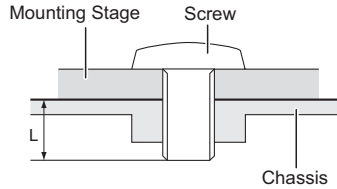

### CAUTION

When using the wall mounting, consideration of thickness of the mounting stage needs to be taken. Tighten the M4/M6\* Screw with washer which "L" length is 5mm to fasten the monitor. Using a screw longer than this may cause electric shock or damage because it may contact with the electrical parts inside the monitor.

- \* A: M4 screw
- B: M6 screw

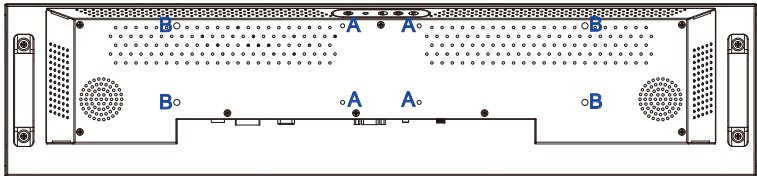

## [ROTATING THE DISPLAY]

It is designed to be compatible in both landscape and portrait modes.

ENGLISH

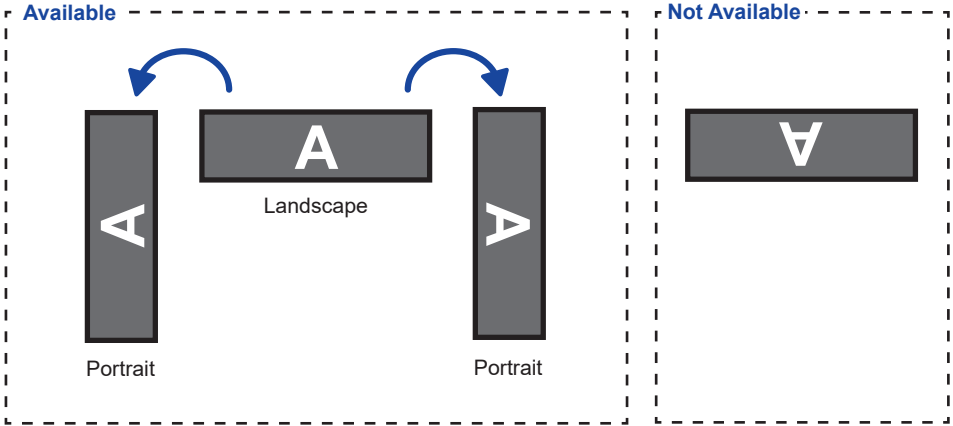

## CONNECTING YOUR MONITOR

- ① Ensure that both the computer and the monitor are switched off.
- ② Connect the computer to the monitor with the signal cable.
- ③ Connect the Light Sensor Cable to the monitor.
- ④ Connect the Power Cable to the monitor first and then to the power source.
- ⑤ Turn on your monitor and computer.

### NOTE

- The signal cables used for connecting the computer and monitor may vary with the type of computer used. An incorrect connection may cause serious damage to both the monitor and the computer. The cable supplied with the monitor is for a standard connector. If a special cable is required please contact your local iiyama dealer or regional iiyama office.
- For connection to Macintosh computers, contact your local iiyama dealer or regional iiyama office for a suitable adaptor.
- Make sure you tighten the finger screws at each end of the Signal Cable.
- The Class I pluggable equipment Type A must be connected to protective earth.
- The socket-outlet shall be installed near the equipment and shall be easily accessible.

[Example of Connection]

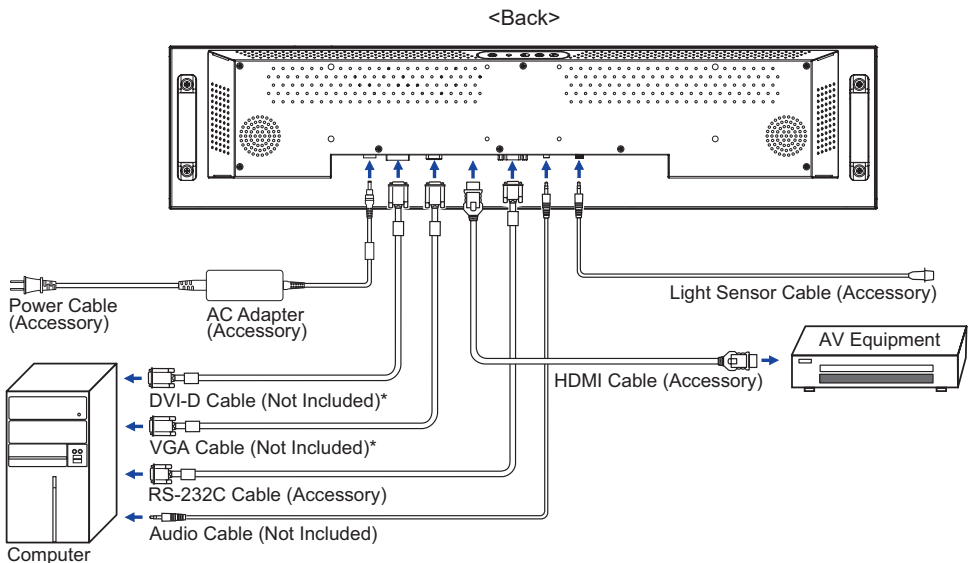

\* Cable is not supplied with the monitor. If you use low quality cable, it may cause a result of electro-magnetic interference. Please contact the iiyama Support Centre in your country if you wish to connect the monitor via the VGA or DVI input.

## COMPUTER SETTING

### ■ Signal Timing

Change to the desired signal timing listed on page 28: COMPLIANT TIMING.



# OPERATING THE MONITOR

To create the best picture, your iiyama LCD monitor has been preset at the factory with the COMPLIANT TIMING shown on page 28. You are also able to adjust the picture by following the button operation shown below. For more detailed adjustments, see page 22 for SCREEN ADJUSTMENTS.

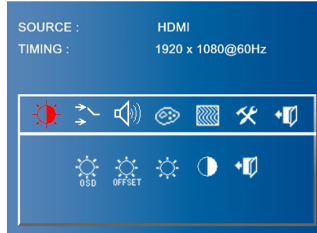
- ① Press the MENU button to start the On Screen Display feature. There are additional Menu items which can be switched by using the < / > buttons.



- ② Select the Menu item of the adjustment you want to make. Press the MENU button and enter the menu page.
- ③ Use the < / > buttons to make the appropriate adjustment or setting.
- ④ Press the MENU button to leave the menu, and the settings you just made would be automatically saved.

For example, to correct for vertical position, select Menu item of  "Image" by using the < / > buttons. Press the MENU button. Then, select  "V. Position" by using the < / > buttons. Press the MENU button.

Use the < / > buttons to change the vertical position settings. The vertical position of the overall display should be changing accordingly while you are doing this.

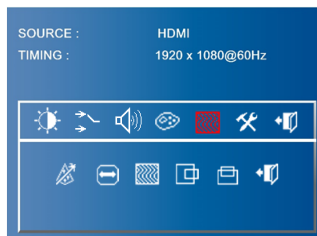

Press the MENU button on the remote control lastly, it ends, all changes are saved in the memory.

## NOTE

- When button operations are aborted during adjustment, On-Screen Display disappears when the time set for the OSD Timeout has passed. Also, the MENU button can be used to return previous menu and turn off the On-Screen Display.
- Any changes are automatically saved in the memory when the On Screen Display disappears. Turning off the power should be avoided while using the Menu.
- Adjustments for Image Position, Clock and Phase are saved for each signal timing. Except for these adjustments, all other adjustments have only one setting which applies to all signal timings.











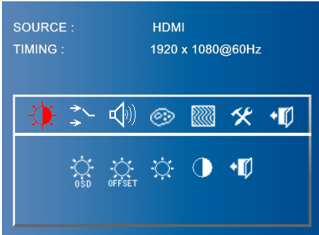

## [LOCK MODE]

- **Back Controller Button:**

Pressing and holding the MENU and > buttons when Menu is not displayed, will lock/unlock the Back Controller Button Lock function.

## ADJUSTMENT MENU CONTENTS

Adjustment Item		Problem / Option	Button to Press
			
 OSD Brightness	 Ambient Light Sensor* <sup>1</sup>	Automatically adjust image brightness to changing ambient lighting conditions.	
 Ambient Light Sensor with OSD offset* <sup>1</sup>		Adjust to minimum brightness according to your application.	
 Brightness* <sup>2</sup> <b>Direct</b>	Too dark Too bright	 	
 Contrast	Too dull Too intense	 	
 Exit	Return to Menu.		

\*<sup>1</sup> Available when the Light Sensor Cable is connected.

\*<sup>2</sup> Adjust the Brightness when you are using the monitor in a dark room and feel the screen is too bright.

### Direct

You can skip the Menu items and directly display an adjustment scale by using the following button operations.

- Brightness : Press the < button when the Menu is not displayed.

Adjustment Item		Problem / Option	Button to Press
Signal Select	<b>Direct</b>	VGA	Select the Analog (VGA) input.
		DVI	Select the Digital (DVI) input.
		HDMI	Select the Digital (HDMI) input.
		AV	Not available on this model.
		S-VIDEO	Not available on this model.
		YPbPr	Not available on this model.
		Exit	Return to Menu.

### Direct







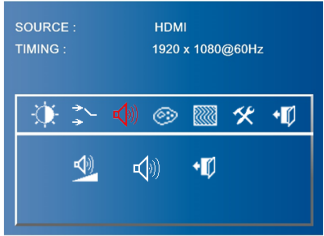

You can skip the Menu items and directly display an option setting screen by using the following button operations.

- Signal Select : Press the > button when the Menu is not displayed.















# Sound











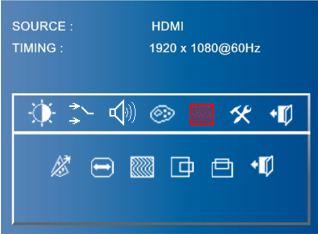



















Adjustment Item	Problem / Option		Button to Press
 Volume	Too soft Too loud		   
 Mute		Return the sound volume to the previous level.	
		Turn off the sound temporarily.	
 Exit	Return to Menu.		

 **Color**











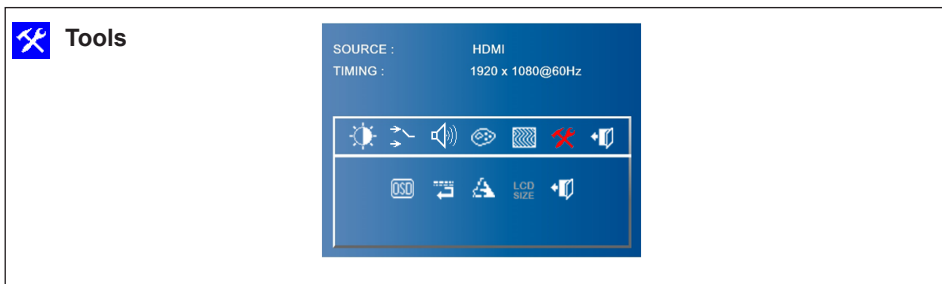

















Adjustment Item	Problem / Option	Button to Press												
 Color Adjustment	Adjusts color automatically.													
 sRGB	sRGB													
<p><b>NOTE</b> ■ sRGB is an international standard which defines and unifies the difference of color appearance between equipment.</p>														
 Color Temperature	<table border="1"> <tr> <td data-bbox="389 616 423 647"></td> <td data-bbox="432 616 596 647">User</td> </tr> <tr> <td data-bbox="389 647 423 679">Red</td> <td data-bbox="432 647 596 679">Too weak</td> </tr> <tr> <td data-bbox="389 679 423 711">Green</td> <td data-bbox="432 679 596 711">Too strong</td> </tr> <tr> <td data-bbox="389 711 423 743">Blue</td> <td data-bbox="432 711 596 743"></td> </tr> </table>		User	Red	Too weak	Green	Too strong	Blue		<table border="1"> <tr> <td data-bbox="613 616 684 647">Too weak</td> <td data-bbox="925 616 997 647"></td> </tr> <tr> <td data-bbox="613 647 684 679">Too strong</td> <td data-bbox="925 647 997 679"></td> </tr> </table>	Too weak		Too strong	
		User												
	Red	Too weak												
	Green	Too strong												
Blue														
Too weak														
Too strong														
<table border="1"> <tr> <td data-bbox="389 695 423 727">Warm</td> <td data-bbox="432 695 596 727">Warm</td> </tr> </table>	Warm	Warm												
Warm	Warm													
<table border="1"> <tr> <td data-bbox="389 735 423 767">Cool</td> <td data-bbox="432 735 596 767">Cool</td> </tr> </table>	Cool	Cool												
Cool	Cool													
 Exit	Return to Menu.													

 <b>Image *1</b>		
Adjustment Item	Problem / Option	Button to Press
 Auto Adjustment *2	Adjusts H. Position, V. Position, Clock and Phase automatically.	
 Clock	 Too narrow  Too wide	   
 Phase	To correct flickering text or lines	   
 H. Position	 Too left  Too right	   
 V. Position	 Too low  Too high	   
 Exit	Return to Menu.	

\*1 Only VGA input.

\*2 For best results, use the Auto Adjust in conjunction with the adjustment pattern. See page 22 for SCREEN ADJUSTMENTS.



Adjustment Item	Problem / Option		Button to Press
 OSD Control	 OSD timeout	You can set the OSD display duration time between 3 and 27 seconds.	   
	 OSD H. Position	OSD is too left OSD is too right	   
	 OSD V. Position	OSD is too low OSD is too high	   
	 Exit	Return to Menu.	
 Reset	Factory-preset data is restored.		
 Sharpness	Too soft Too sharp		   
 LCD Size	Not available on this model.		
 Exit	Return to Menu.		



**Exit**

SOURCE : HDMI  
TIMING : 1920 x 1080@60Hz



Adjustment Item	Problem / Option	Button to Press
Exit	Exit.	



## SCREEN ADJUSTMENTS

Adjust the image by following the procedure below to get the desired picture when selecting Analog input.

- The screen adjustments described in this manual are designed to set image position and minimize flicker or blur for the particular computer in use.
- The monitor is designed to provide the best performance at resolution of 1920 × 1080, but can not provide the best at resolutions of less than 1920 × 1080 because the picture is automatically stretched to fit the full screen. It is recommended to operate at resolution of 1920 × 1080 in normal use.
- Displayed text or lines will be blurred or irregular in thickness when the picture is stretched due to the screen enlargement process.
- It is preferable to adjust the image position and frequency with the monitor controls, rather than the computer software or utilities.
- Perform adjustments after a warm-up period of at least thirty minutes.
- Additional adjustments may be required after the Auto Adjust depending on the resolution or signal timing.
- The Auto Adjust may not work correctly when displaying the picture other than the screen adjustment pattern. In this case, manual adjustments are required.

There are two ways to adjust the screen. One way is automatic adjustment for Position, Clock and Phase. The other way is performing each adjustment manually.

Perform the Auto Adjust first when the monitor is connected to a new computer, or resolution is changed. If the screen has a flicker or blur, or the picture does not fit in the display area after performing the Auto Adjust, manual adjustments are required. Both adjustments should be made by using the screen adjustment pattern (Test.bmp) obtained via the Iiyama web site (<http://www.iiyama.com>).

Adjust the image by following the procedure below to get the desired picture.  
This manual explains adjustment under Windows® OS.

- ① **Display the picture at the optimum resolution.**
- ② **Enter the Test.bmp (screen adjustment pattern) to wallpaper.**

- NOTE**
- Consult the appropriate documentation for doing this.
  - Set the display position to center in the wallpaper setting dialogue box. If you use Microsoft® PLUS! 95/98 cancel the setting of "Stretch desktop wallpaper to fit the screen".

[Adjustment pattern]

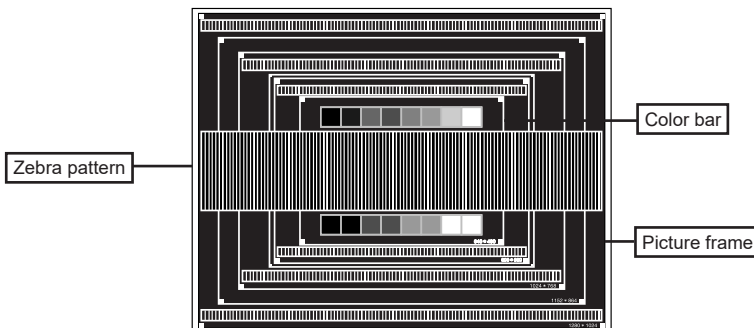

- ③ Adjust the Auto Adjustment.
- ④ Adjust the image manually by following procedure below when the screen has a flicker or blur, or the picture does not fit in the display area after performing the Auto Adjust.
- ⑤ Adjust the V. Position so that the top and bottom of the picture frame will fit to the display area.

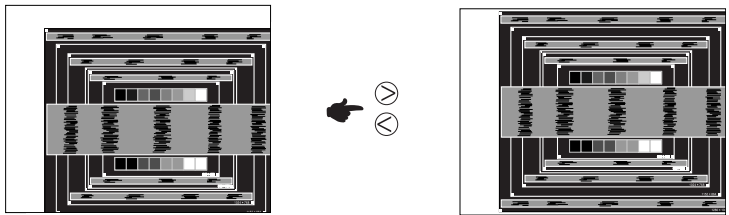

- ⑥ 1) Adjust the H. Position so that the left side of the picture frame will move to the left edge of the display area.

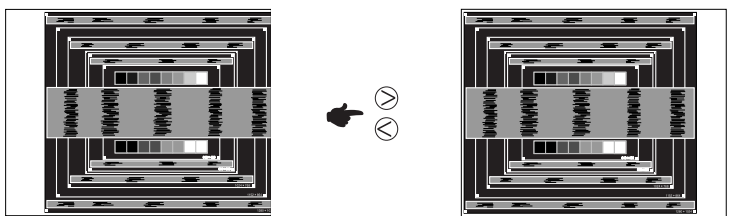

- 2) Stretch the right side of the picture frame to the right edge of the display area by adjusting the Clock.

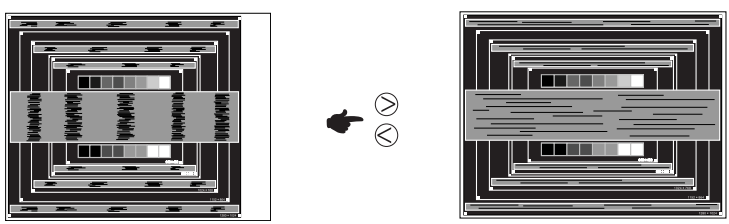

- NOTE**
- When the left side of the picture frame moves apart from the left edge of the display area during the Clock adjustment, adjust steps 1) and 2).
  - Another way to make the Clock adjustment is to correct the vertical wavy lines in the zebra pattern.
  - The picture may flicker during the Clock, H./V. Position adjustment.
  - In case the picture frame is bigger or smaller than the data display area after the Clock adjustment, repeat steps from ③.

- ⑦ Adjust the Phase to correct horizontal wavy noise, flicker or blur in the zebra pattern.

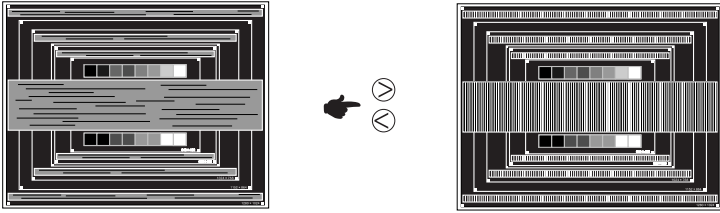

**NOTE**

- In case the strong flicker or blurs remain on a part of the screen, repeat steps ⑥ and ⑦ because the Clock may not be adjusted correctly. If the flicker or blurs still remain, set the refresh rate of computer to low (60Hz) and repeat steps from ③ again.
- Adjust the H. Position after the Phase adjustment if the horizontal position moves during the adjustment.

- ⑧ Adjust the Brightness and Color to get the desired picture after you complete the Clock and Phase adjustments.

Put back your favorite wallpaper.

# TROUBLE SHOOTING

If the monitor fails to operate correctly, please follow the steps below for a possible solution.

1. Perform the adjustments described in OPERATING THE MONITOR, depending on the problem you have. If the monitor does not get a picture, skip to 2.
2. Consult the following items if you cannot find an appropriate adjustment item in OPERATING THE MONITOR or if the problem persists.
3. If you are experiencing a problem which is not described below or you cannot correct the problem, discontinue using the monitor and contact your dealer or iiyama service center for further assistance.

Problem	Check
① The picture does not appear. (Power indicator does not light up.)  (Power indicator is green.)  (Power indicator is red.)	<input type="checkbox"/> The Power Cable is firmly seated in the socket. <input type="checkbox"/> The Power Switch is turned ON. <input type="checkbox"/> The AC socket is live. Please check with another piece of equipment. <input type="checkbox"/> If the blank screen saver is in active mode, touch the keyboard or the mouse. <input type="checkbox"/> Increase the Contrast and/or Brightness. <input type="checkbox"/> The computer is ON. <input type="checkbox"/> The Signal Cable is properly connected. <input type="checkbox"/> The signal timing of the computer is within the specification of the display. <input type="checkbox"/> If the display is in power management mode, touch the keyboard or the mouse. <input type="checkbox"/> The computer is ON. <input type="checkbox"/> The Signal Cable is properly connected. <input type="checkbox"/> The signal timing of the computer is within the specification of the display.
② The screen is not synchronized.	<input type="checkbox"/> The Signal Cable is properly connected. <input type="checkbox"/> The signal timing of the computer is within the specification of the monitor. <input type="checkbox"/> The video output level of the computer is within the specification of the monitor.
③ The screen position is not in the center.	<input type="checkbox"/> The signal timing of the computer is within the specification of the monitor.
④ The screen is too bright or too dark.	<input type="checkbox"/> The video output level of the computer is within the specification of the monitor.
⑤ The screen is shaking.	<input type="checkbox"/> The power voltage is within the specification of the monitor. <input type="checkbox"/> The signal timing of the computer is within the specification of the monitor.
⑥ No sound.	<input type="checkbox"/> The audio equipment (computer etc.) is ON. <input type="checkbox"/> The Audio Cable is properly connected. <input type="checkbox"/> The Volume is turned up. <input type="checkbox"/> The Mute is OFF. <input type="checkbox"/> The audio output level of the audio equipment is within the specification of the monitor.
⑦ The sound is too loud or too quiet.	<input type="checkbox"/> The audio output level of the audio equipment is within the specification of the monitor.
⑧ A strange noise is heard.	<input type="checkbox"/> The Audio Cable is properly connected.

# RECYCLING INFORMATION

For better environment protection please don't dispose your monitor.  
Please visit our web site: [www.iiyama.com](http://www.iiyama.com) for monitor recycling.

# APPENDIX

Design and specifications are subject to change without prior notice.

## SPECIFICATIONS : ProLite S2820HSB

Size Category		28"
LCD Panel	Panel technology	IPS technology
	Size	Diagonal: 28" (71.2cm)
	Pixel pitch	0.1215mm H × 0.3645mm V
	Brightness	1000cd/m <sup>2</sup> (Typical)
	Contrast ratio	1000 : 1 (Typical)
	Viewable angle	Horizontal : 178 degrees, Vertical: 178 degrees (Typical)
	Response time	8ms (Typical)
Display Colors		Approx. 16.7M
Sync Frequency		Analog: Horizontal: 30.0-83.0kHz, Vertical: 50-76Hz Digital: Horizontal: 30.0-83.0kHz, Vertical: 50-76Hz
Maximum Resolution		1920 × 360, 0.7 MegaPixels
Input Connector		VGA, DVI, HDMI
Serial Port		RS-232C In
Plug & Play		VESA DDC2B™
Input Sync Signal		Separate sync: TTL, Positive or Negative
Input Video Signal		Analog: 0.7Vp-p (Standard), 75Ω, Positive Digital: DVI (Digital Visual Interface Standard Rev.1.0) compliance Digital: HDMI
Input Audio Connector		ø 3.5mm mini jack (Stereo)
Input Audio Signal		0.5Vrms maximum
Speakers		5W×2 (Stereo speakers)
Light Sensor Connector		mini jack
Maximum Screen Size		699.84mm W × 131.22mm H / 27.6" W × 5.2" H
Power Source		12VDC 5.0A
AC Adapter (accessory)		Input: 100-240VAC, 50-60Hz
Power Consumption*		28W typical Energy Efficiency Class: C
Dimensions / Net Weight		737.0 × 170.0 × 58.0mm / 29.0 × 6.7 × 2.3" (W×H×D) 5.4kg / 11.9lbs
Environmental Considerations		Operating: Temperature 0 to 50°C / 32 to 122°F Humidity 85% (No condensation) Storage: Temperature -20 to 60°C / 4 to 140°F Humidity 85% (No condensation)
Approvals		CB, CE

**NOTE** \* Audio equipment are not connected.

## DIMENSIONS : ProLite S2820HSB

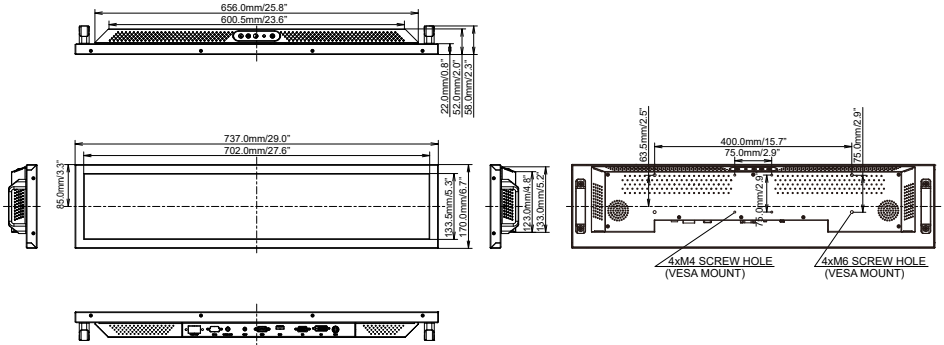

## COMPLIANT TIMING

Video Mode	Horizontal Frequency	Vertical Frequency	Dot Clock
640 × 480	31.469kHz	59.940Hz	25.175MHz
800 × 600	37.879kHz	60.317Hz	40.000MHz
1024 × 768	48.363kHz	60.004Hz	65.000MHz
1280 × 1024	63.981kHz	60.020Hz	108.000MHz
1680 × 1050	65.290kHz	60.000Hz	146.250MHz
1920 × 1080	66.590kHz	59.930Hz	138.500MHz