

## Evrensel duvar montajı, maks. 800x600mm. 125kg

With the easy and quick fixation system, this wall mount guarantees safe usage in environments like schools and other public utility buildings.

### 01 TEKNİK ÖZELLİK

Maksimum ağırlık kapasitesi	125kg / monitör
VESA minimum	100 x 100mm
VESA maksimum	800 x 600mm

# MD-WM8060

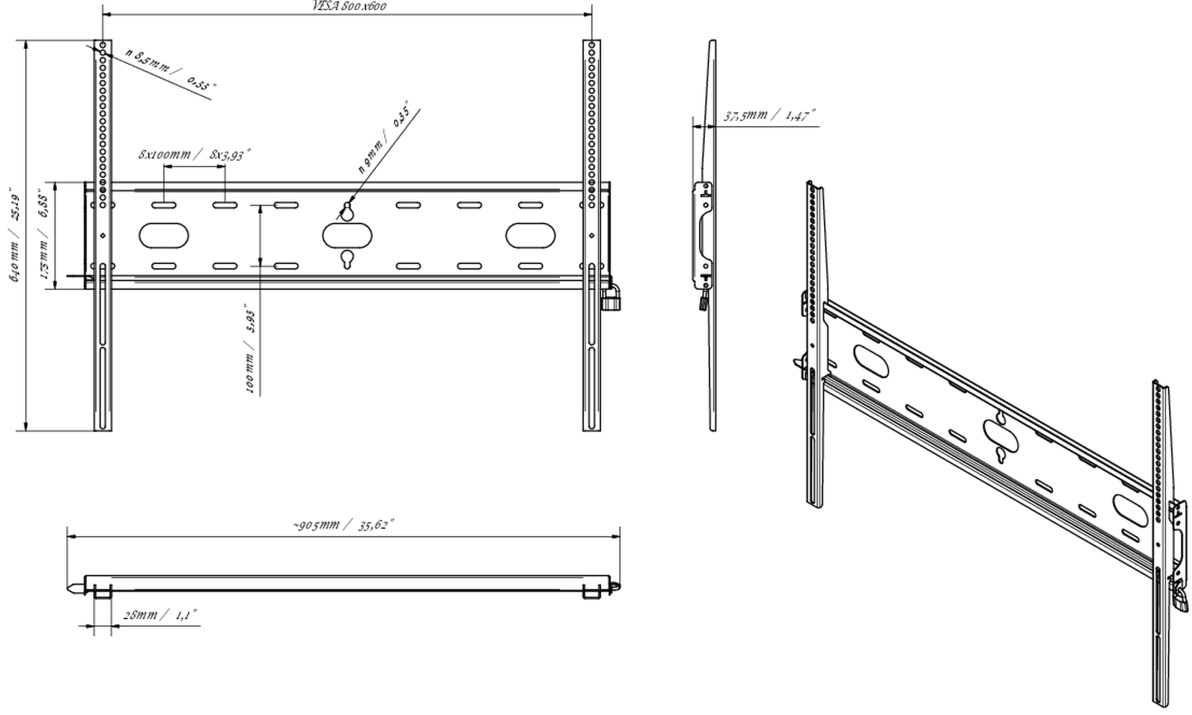

## 02 ÖLÇÜLER / AĞIRLIK

Ürün boyutları G x Y x D	860 x 640 x 37.5mm
Kutu boyutları G x Y x D	930 x 220 x 40mm
Ağırlık (kutu hariç)	3.3kg
Ağırlık (kutu ile birlikte)	4kg
EAN kodu	5902841107380

# MD-WM8060

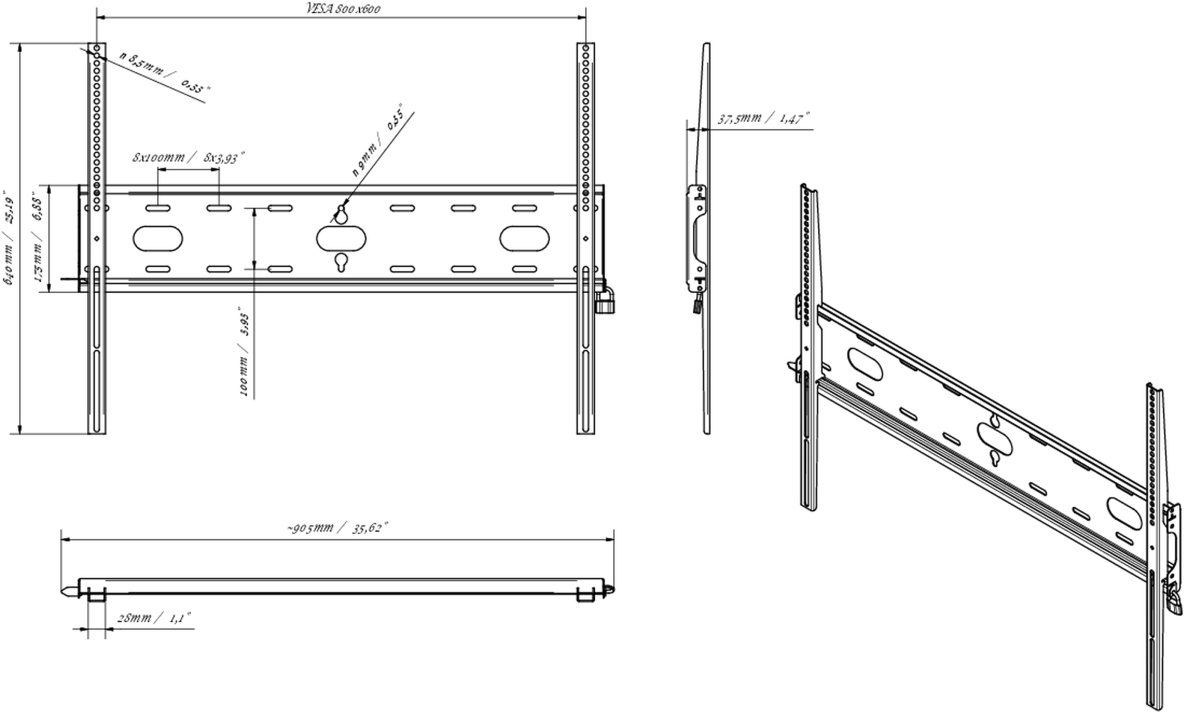

All trademarks and registered trademarks acknowledged. E & O E. Specification subject to change without notice. All LCD's comply with ISO-9241-307:2008 in connection with pixel defects.

© IIYAMA CORPORATION. ALL RIGHTS RESERVED