

Extra safe wall mount for screens 26-55 inch, up to VESA 400x400mm, max 30kg

With a three-step fixation system, this wall mount guarantees extra safe usage in environments like schools and other public utility buildings. First, the vertical brackets are mounted to the display. The wall mount back plate is then screwed to the wall. And for additional safety, the vertical VESA mount brackets can be securely fastened to the wall back plate with two extra fastening screws. Please note: for iiyama touch models we recommend using [MD 052B1000](#)

01 DIMENSIONS / WEIGHT

EAN code

4948570032228

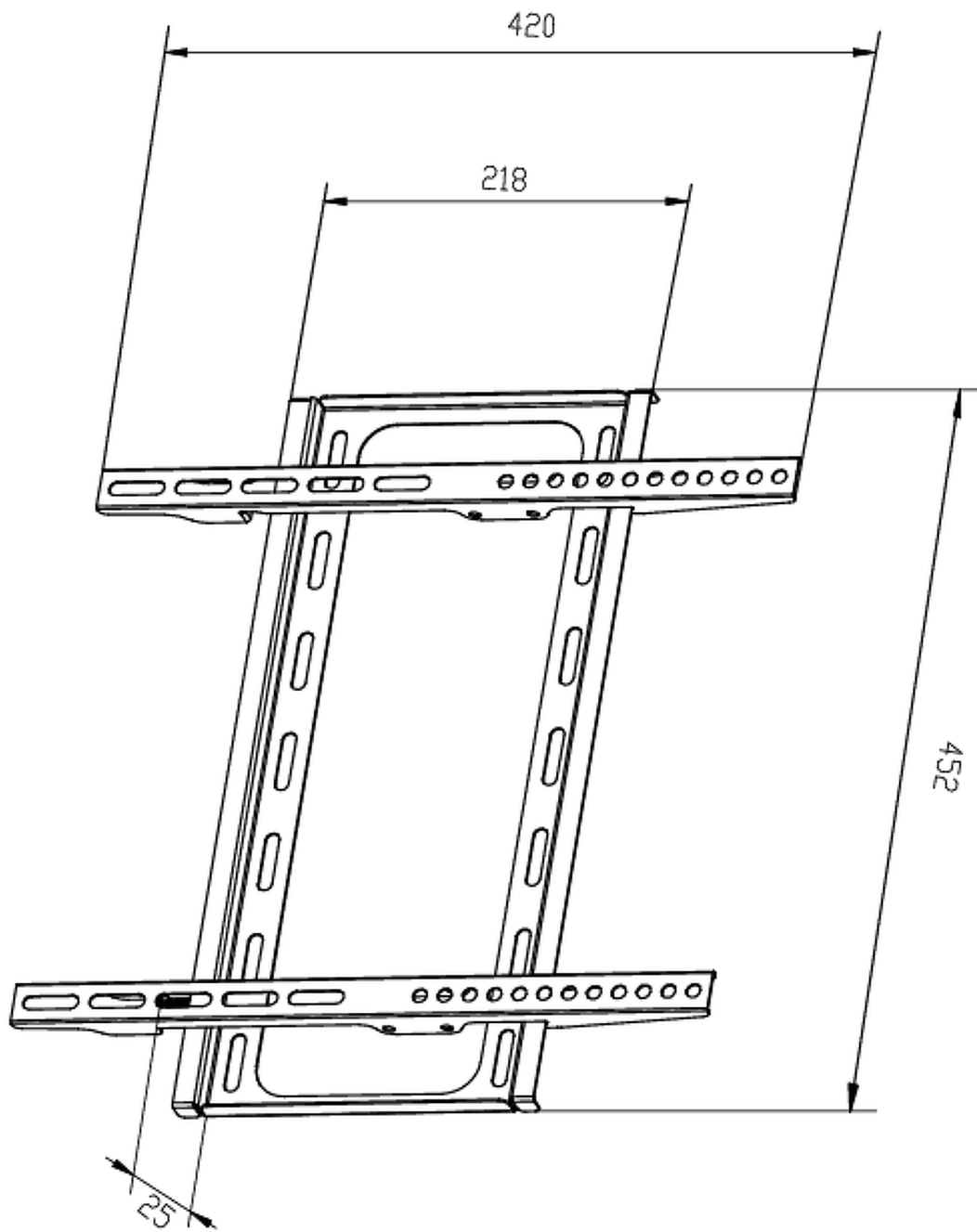

All trademarks and registered trademarks acknowledged. E & O E. Specification subject to change without notice. All LCD's comply with ISO-9241-307:2008 in connection with pixel defects.

© IIYAMA CORPORATION. ALL RIGHTS RESERVED

26.04.2024 12:24:56